

6469C

32 v 300 A

Power Supp.



HEWLETT  
PACKARD



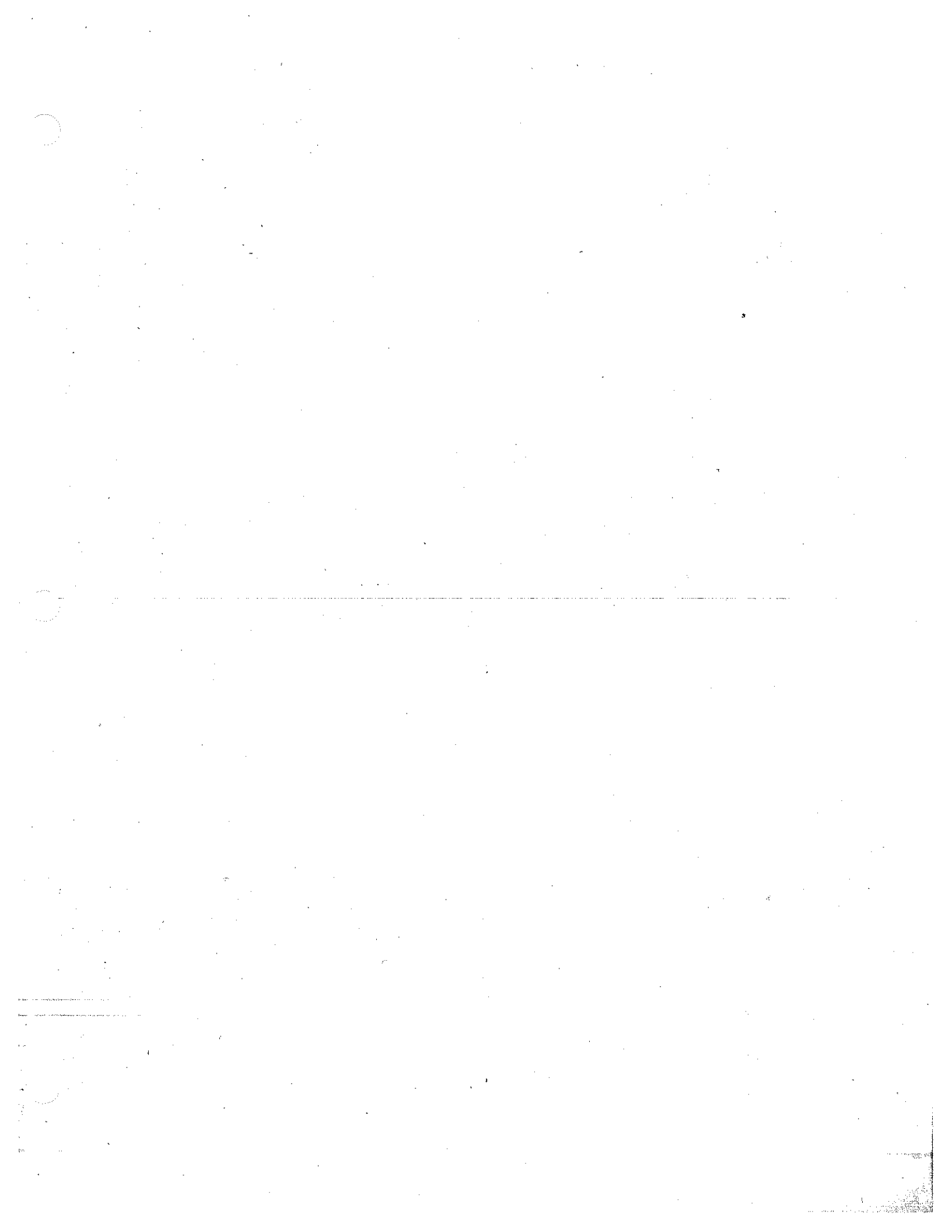



HEWLETT  
PACKARD

### CERTIFICATION

*Hewlett-Packard Company certifies that this product met its published specifications at the time of shipment from the factory. Hewlett-Packard further certifies that its calibration measurements are traceable to the United States National Bureau of Standards, to the extent allowed by the Bureau's calibration facility, and to the calibration facilities of other International Standards Organization members.*

### WARRANTY

This Hewlett-Packard instrument product is warranted against defects in material and workmanship for a period of one year from date of shipment. During the warranty period, Hewlett-Packard Company will, at its option, either repair or replace products which prove to be defective.

For warranty service or repair, this product must be returned to a service facility designated by HP. Buyer shall prepay shipping charges to HP and HP shall pay shipping charges to return the product to Buyer. However, Buyer shall pay all shipping charges, duties, and taxes for products returned to HP from another country.

HP warrants that its software and firmware designated by HP for use with an instrument will execute its programming instructions when properly installed on that instrument. HP does not warrant that the operation of the instrument, or software, or firmware will be uninterrupted or error free.

### LIMITATION OF WARRANTY

The foregoing warranty shall not apply to defects resulting from improper or inadequate maintenance by Buyer, Buyer-supplied software or interfacing, unauthorized modification or misuse, operation outside of the environmental specifications for the product, or improper site preparation or maintenance.

NO OTHER WARRANTY IS EXPRESSED OR IMPLIED. HP SPECIFICALLY DISCLAIMS THE IMPLIED WARRANTIES OF MERCHANTABILITY AND FITNESS FOR A PARTICULAR PURPOSE.

### EXCLUSIVE REMEDIES

THE REMEDIES PROVIDED HEREIN ARE BUYER'S SOLE AND EXCLUSIVE REMEDIES. HP SHALL NOT BE LIABLE FOR ANY DIRECT, INDIRECT, SPECIAL, INCIDENTAL, OR CONSEQUENTIAL DAMAGES, WHETHER BASED ON CONTRACT, TORT, OR ANY OTHER LEGAL THEORY.

### ASSISTANCE

*Product maintenance agreements and other customer assistance agreements are available for Hewlett-Packard products.*

*For any assistance, contact your nearest Hewlett-Packard Sales and Service Office. Addresses are provided at the back of this manual.*



DC POWER SUPPLY  
SCR-10 SERIES  
MODEL 6469C

OPERATING AND SERVICE MANUAL  
FOR SERIALS 1125A - 0101 AND ABOVE\*

\*For Serials Above 1125A - 0101  
a change page may be included.

100 Locust Avenue, Berkeley Heights, New Jersey 07922

## TABLE OF CONTENTS

Section	Page
<b>I GENERAL INFORMATION .....</b>	<b>1-1</b>
1-1 Description .....	1-1
1-5 Specifications .....	1-1
1-7 Options .....	1-2
1-9 Accessories .....	1-2
1-11 Instrument/Manual Identification .....	1-2
1-14 Ordering Additional Manuals .....	1-2
 <b>II INSTALLATION .....</b>	 <b>2-1</b>
2-1 Initial Inspection .....	2-1
2-3 Mechanical Check .....	2-1
2-5 Electrical Check .....	2-1
2-7 Installation Data .....	2-1
2-9 Location .....	2-1
2-11 Outline Diagram .....	2-1
2-13 Rack Mounting .....	2-2
2-15 Input Power Requirements .....	2-2
2-20 208/230Vac Conversion .....	2-2
2-22 380/400Vac Conversion .....	2-2
2-30 50Hz Ac Input (Option 005) .....	2-3
2-32 Repackaging for Shipment .....	2-3
 <b>III OPERATING INSTRUCTIONS .....</b>	 <b>3-1</b>
3-1 Turn-On Checkout Procedure .....	3-1
3-3 Operating Modes .....	3-2
3-5 Normal Operating Mode .....	3-2
3-7 Constant Voltage .....	3-2
3-9 Constant Current .....	3-2
3-11 No Load Operation .....	3-3
3-13 Output Ranges — Models 6466C and 6483C Only .....	3-3
3-15 Connecting Load .....	3-3
3-18 Grounding .....	3-3
3-21 Operation Beyond Rated Output .....	3-3
3-23 Protection Circuits .....	3-3
3-25 Optional Operating Modes .....	3-3
3-26 Remote Programming, Constant Voltage .....	3-3
3-34 Remote Programming, Constant Current .....	3-4
3-40 Remote Sensing .....	3-5
3-45 Auto-Parallel Operation .....	3-6
3-48 Auto-Series Operation .....	3-6
3-53 Battery Charging .....	3-7
3-58 Battery Discharging .....	3-8
3-62 Special Operating Considerations .....	3-8
3-63 Pulse Loading .....	3-8

## TABLE OF CONTENTS (Continued)

Section	Page
<b>IV PRINCIPLES OF OPERATION</b> .....	<b>4-1</b>
4-1 Overall Block Diagram Discussion .....	4-1
4-3 Feedback Loop .....	4-1
4-9 Current Balance Circuit .....	4-2
4-11 Turn-On Control Circuit .....	4-2
4-13 Overvoltage Protection Feature .....	4-3
4-15 Overcurrent Protection Circuit .....	4-3
4-17 Early Overcurrent Protection Circuit .....	4-3
4-20 Phase Protection Circuit .....	4-3
4-22 Overload Circuit .....	4-3
4-26 Reference Supply .....	4-3
4-28 Overvoltage Crowbar .....	4-3
4-30 Detailed Circuit Analysis .....	4-4
4-31 SCR Regulator and Firing Circuits .....	4-4
4-45 Constant Voltage Comparator .....	4-5
4-51 Comparator Protection Circuit .....	4-6
4-53 Constant Current Comparator .....	4-6
4-57 Error Amplifier .....	4-6
4-61 Overcurrent Protection Circuit .....	4-6
4-63 Turn-On Control .....	4-6
4-65 Overvoltage Protection Circuit .....	4-6
4-67 Phase Protection Circuit .....	4-7
4-70 Early Overcurrent Protection .....	4-7
4-73 Current Balance Circuit .....	4-7
4-78 Overload Circuit .....	4-7
4-85 Reference Supply .....	4-8
<b>V MAINTENANCE</b> .....	<b>5-1</b>
5-1 Introduction .....	5-1
5-3 Test Equipment Required .....	5-1
5-5 Performance Test .....	5-2
5-7 Constant Voltage Tests .....	5-2
5-27 Constant Current Tests .....	5-5
5-35 Troubleshooting .....	5-6
5-40 Overall Troubleshooting Procedure .....	5-6
5-44 Amplifier Circuits, Open Loop Troubleshooting .....	5-9
5-49 Firing Circuits, Open Loop Troubleshooting .....	5-10
5-51 Crowbar Troubleshooting .....	5-11
5-54 Repair and Replacement .....	5-11
5-56 Air Filter .....	5-11
5-58 Hinged Front Panel .....	5-11
5-60 Printed Circuit Boards .....	5-11
5-62 Primary SCR and Diode Replacement .....	5-12
5-66 Location of Power Transformer, Choke, Output Capacitors, and Secondary Rectifiers....	5-12
5-68 Adjustment and Calibration .....	5-12
5-70 Meter Zero .....	5-12

## SAFETY SUMMARY

*The following general safety precautions must be observed during all phases of operation, service, and repair of this instrument. Failure to comply with these precautions or with specific warnings elsewhere in this manual violates safety standards of design, manufacture, and intended use of the instrument. Hewlett-Packard Company assumes no liability for the customer's failure to comply with these requirements.*

### BEFORE APPLYING POWER.

Verify that the product is set to match the available line voltage and the correct fuse is installed.

### GROUND THE INSTRUMENT.

This product is a Safety Class 1 instrument (provided with a protective earth terminal). To minimize shock hazard, the instrument chassis and cabinet must be connected to an electrical ground. The instrument must be connected to the ac power supply mains through a three-conductor power cable, with the third wire firmly connected to an electrical ground (safety ground) at the power outlet. For instruments designed to be hard-wired to the ac power lines (supply mains), connect the protective earth terminal to a protective conductor before any other connection is made. Any interruption of the protective (grounding) conductor or disconnection of the protective earth terminal will cause a potential shock hazard that could result in personal injury. If the instrument is to be energized via an external autotransformer for voltage reduction, be certain that the autotransformer common terminal is connected to the neutral (earthed pole) of the ac power lines (supply mains).

### INPUT POWER MUST BE SWITCH CONNECTED.

For instruments without a built-in line switch, the input power lines must contain a switch or another adequate means for disconnecting the instrument from the ac power lines (supply mains).

### DO NOT OPERATE IN AN EXPLOSIVE ATMOSPHERE.

Do not operate the instrument in the presence of flammable gases or fumes.

### KEEP AWAY FROM LIVE CIRCUITS.

Operating personnel must not remove instrument covers. Component replacement and internal adjustments must be made by qualified service personnel. Do not replace components with power cable connected. Under certain conditions, dangerous voltages may exist even with the power cable removed. To avoid injuries, always disconnect power, discharge circuits and remove external voltage sources before touching components.

### DO NOT SERVICE OR ADJUST ALONE.

Do not attempt internal service or adjustment unless another person, capable of rendering first aid and resuscitation, is present.

### DO NOT EXCEED INPUT RATINGS.

This instrument may be equipped with a line filter to reduce electromagnetic interference and must be connected to a properly grounded receptacle to minimize electric shock hazard. Operation at line voltages or frequencies in excess of those stated on the data plate may cause leakage currents in excess of 5.0 mA peak.

### SAFETY SYMBOLS.



Instruction manual symbol: the product will be marked with this symbol when it is necessary for the user to refer to the instruction manual (refer to Table of Contents).



Indicates hazardous voltages.



or



Indicate earth (ground) terminal.

### WARNING

The WARNING sign denotes a hazard. It calls attention to a procedure, practice, or the like, which, if not correctly performed or adhered to, could result in personal injury. Do not proceed beyond a WARNING sign until the indicated conditions are fully understood and met.

### CAUTION

The CAUTION sign denotes a hazard. It calls attention to an operating procedure, or the like, which, if not correctly performed or adhered to, could result in damage to or destruction of part or all of the product. Do not proceed beyond a CAUTION sign until the indicated conditions are fully understood and met.

### DO NOT SUBSTITUTE PARTS OR MODIFY INSTRUMENT.

Because of the danger of introducing additional hazards, do not install substitute parts or perform any unauthorized modification to the instrument. Return the instrument to a Hewlett-Packard Sales and Service Office for service and repair to ensure that safety features are maintained.

*Instruments which appear damaged or defective should be made inoperative and secured against unintended operation until they can be repaired by qualified service personnel.*



## SECTION I GENERAL INFORMATION

### 1-1 DESCRIPTION

1-2 This power supply, Figure 1-1, is completely transistorized and is suitable for high power applications which require a dc source with a moderate degree of regulation. The supply is a constant voltage/constant current type that will furnish full rated output voltage at the maximum rated output current or can be continuously adjusted throughout most of the output range. The front panel CURRENT controls can be used to establish the output current limit (overload or short circuit) when the supply is used as a constant voltage source and the VOLTAGE controls can be used to establish the voltage limit (ceiling) when the supply is used as a constant current source. The supply will automatically cross over from constant voltage to constant current operation and vice versa if the output current or voltage exceeds these preset limits.

1-3 Many protection circuits are included in the supply to protect the regulator SCR's against excessive current or voltage and to protect the user's load. The supply also contains the front panel trouble lamps associated with some of the protection circuits.

1-4 Output voltage and current are continuously monitored on two front panel meters. Input power is connected to a four pin connector on the rear of the unit. The output terminals are heavy busbars also mounted at the rear of the unit. Terminal strips at the rear of the unit allow ease in expanding the operational capabilities of the instrument. A brief description of these capabilities is given below:

a. *Remote Programming.* The power supply output voltage or current may be programmed (controlled) from a remote location by means of an external voltage source or resistance.

b. *Remote Sensing.* The degradation in regulation which occurs at the load due to voltage drop in the load leads can be reduced by using the power supply in the remote sensing mode of operation.

c. *Auto-Series Operation.* Two power supplies may be used in series when a higher output voltage is required in the constant voltage mode of operation or when greater voltage compliance is required in the constant current mode of operation. Auto-Series operation permits one-knob control of the total output voltage from a "master" supply.

d. *Auto-Parallel Operation.* The power supply may be operated in parallel with another unit when greater output

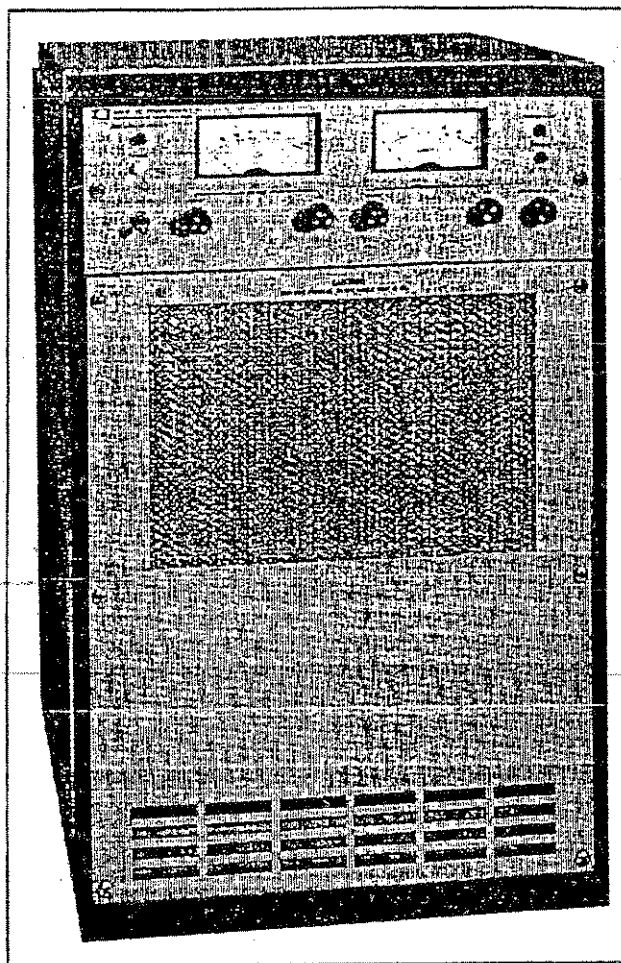

Figure 1-1. Typical 10kW Power Supply, SCR-10 Series

current capability is required. Auto-Parallel operation permits one-knob control of the total output current from a "master" supply.

e. *Battery Charging or Discharging.* The supply can be used in automatic battery charging or discharging applications. The automatic crossover between constant voltage and constant current permits the operation to be unattended.

### 1-5 SPECIFICATIONS

1-6 Detailed specifications for the power supply are given in Table 1-1 on Page 1-3.

## 1-7 OPTIONS

1-8 Options are customer-requested factory modifications of a standard instrument. The following options are available for the instrument covered by this manual. Where necessary, detailed coverage of the options is included throughout the manual. Notice that the customer must specify one of the five input power options available for this supply when ordering a unit. These options (001, 002, 003, 031, and 032), together with the other available options, are described below.

<u>Option No.</u>	<u>Description</u>
001	208Vac $\pm$ 10%, 3-phase input, 57–63Hz.
002	230Vac $\pm$ 10%, 3-phase input, 57–63Hz.
003	460Vac $\pm$ 10%, 3-phase input, 57–63Hz.
005	50Hz ac input. Standard instrument is wired for nominal 60Hz ac input. Option 005 includes re-alignment, and in some cases, internal rewiring.
006	Internal overvoltage protection crowbar ( <i>Not applicable to 6464C</i> ). Protects delicate loads against power supply failure or operator error. Monitors the output voltage and places a virtual short circuit (conducting SCR) across load within 10 $\mu$ s after preset trip voltage is exceeded. For complete specifications, refer to Appendix A.
023	Rack kit for mounting one supply in standard 19" rack.
031	380Vac $\pm$ 10%, 3-phase input, 57–63Hz.
032	400Vac $\pm$ 10%, 3-phase input, 57–63Hz.

## 1-9 Accessories

1-10 One accessory, HP Part No. 14545A, is available with this supply. It consists of four snap-on casters and can be ordered with the power supply or separately from your local Hewlett-Packard sales office.

## 1-11 INSTRUMENT/MANUAL IDENTIFICATION

1-12 This power supply is identified by a three-part serial number tag. The first part is the power supply model number. The second part is the serial number prefix, which consists of a number-letter combination that denotes the date of a significant design change. The number designates the year, and the letter A through M designates the month, January through December, respectively, with "I" omitted. The third part is the power supply serial number; a different sequential number is assigned to each power supply.

1-13 If the serial number on your instrument does not agree with those on the title page of the manual, Change Sheets supplied with the manual or Manual Backdating Changes define the differences between your instrument and the instrument described by this manual.

## 1-14 ORDERING ADDITIONAL MANUALS

1-15 One manual is shipped with each power supply. Additional manuals may be purchased from your local Hewlett-Packard field office (see list at rear of this manual for addresses). Specify the model number, serial number prefix, and HP part number shown on the title page.

Table 1-1. Specifications

<p><b>INPUT:</b> 208/230/380/400/460Vac <math>\pm</math> 10%, Three Phase, 57 to 63Hz, 50A per phase @ 230Vac.</p> <p><b>OUTPUT:</b> 0-36V @ 0-300A (NOTES 1 and 2).</p> <p><b>LOAD REGULATION:</b> <i>Constant Voltage</i> — Less than 0.05% plus 5mV for a load current change equal to the current rating of the supply. <i>Constant Current</i> — Less than 0.1% plus 0.3A for a load voltage change equal to the voltage rating of the supply.</p> <p><b>LINE REGULATION:</b> <i>Constant Voltage</i> — Less than 0.05% plus 5mV for any change within the input rating. <i>Constant Current</i> — Less than 0.1% plus 0.3A for any change within the input rating.</p> <p><b>RIPPLE AND NOISE:</b> <i>Constant Voltage</i> — Less than 180mVrms, 1V p-p (dc to 20MHz). (NOTE 2)</p> <p><b>TEMPERATURE RATINGS:</b> Operating: 0 to 50°C. Storage: -40 to +75°C.</p> <p><b>TEMPERATURE COEFFICIENT:</b> <i>Constant Voltage</i> — Less than 0.03% plus 400<math>\mu</math>V change in output per degree Centigrade change in ambient following 30 minutes warm-up. <i>Constant Current</i> — Less than 0.06% plus 100mA change in output per degree Centigrade change in ambient following 30 minutes warm-up.</p> <p><b>STABILITY:</b> <i>Constant Voltage</i> — Less than 0.15% plus 1mV total drift for 8 hours following 30 minutes warm-up under</p>	<p>constant ambient conditions. <i>Constant Current</i> — Less than 0.4% plus 0.4A total drift for 8 hours following 30 minutes warm-up under constant ambient conditions.</p> <p><b>TRANSIENT RECOVERY TIME:</b> Less than 50ms/100ms is required for output voltage recovery (in constant voltage operation) to within 1.5V/500mV of the nominal output voltage following a load change from full load to half load or vice versa (NOTE 2).</p> <p><b>METERS:</b> A front panel voltmeter (0-40V) and ammeter (0-350A) are provided. (Accuracy is 2% of full scale.)</p> <p><b>RESOLUTION:</b> <i>Constant Voltage</i> — 36mV is the minimum output voltage change that can be obtained with the front panel controls. <i>Constant Current</i> — 0.3A is the minimum output current change that can be obtained using the front panel controls.</p> <p><b>REMOTE RESISTANCE PROGRAMMING:</b> <i>Constant Voltage</i> — 200 ohms/volt (Accuracy: 2%). All programming terminals are on a rear barrier strip. <i>Constant Current</i> — 3.33 ohms/ampere (Accuracy: 2%). All programming terminals are on a rear barrier strip.</p> <p><b>COOLING:</b> Forced air cooling is employed by means of an internal fan.</p> <p><b>WEIGHT:</b> 500 lbs. net. 555 lbs. shipping.</p> <p><b>SIZE:</b> 16-3/4" W x 26-1/4" H x 26-1/8" D. The unit can be mounted in a standard 19" rack panel.</p>
--	--

NOTES:

- Specifications apply only when (a) supply is delivering more than 5% of maximum rated output voltage (CV operation) or 5% of maximum rated output current (CC operation), and (b) load is drawing more than 100W. Restriction (b) is lifted when supply is delivering more than 30% of maximum rated output voltage (CV operation) or 30% of maximum rated output current (CC operation).
- For operation with a 50Hz input (possible only with Option 05), output current is linearly derated from 100% at 40°C to 80% at 50°C. Other specifications (indicated in Table) must be increased by 50% for a 50Hz input.

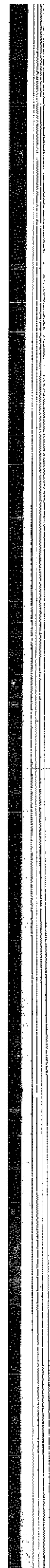

## SECTION II INSTALLATION

### 2-1 INITIAL INSPECTION

2-2 Before shipment, this instrument was inspected and found to be free of mechanical and electrical defects. As soon as the instrument is unpacked, inspect for any damage that may have occurred in transit. Save all packing materials until the inspection is completed. If damage is found, file a claim with the carrier immediately. Hewlett-Packard Sales and Service office should be notified.

### 2-3 Mechanical Check

2-4 This check should confirm that there are no broken knobs or connectors, that the cabinet and panel surfaces are free of dents and scratches, and that the meters are not scratched or cracked.

### 2-5 Electrical Check

2-6 The instrument should be checked against its electrical specifications. Section V includes an "in-cabinet"

performance check to verify proper instrument operation

### 2-7 INSTALLATION DATA

2-8 The instrument is shipped ready for operation. It is necessary only to connect the instrument to a source of power and it is ready for operation.

### 2-9 Location

2-10 This instrument is fan cooled. Sufficient space should be allotted so that a free flow of cooling air can reach the sides of the instrument when it is in operation. It should be used in an area where the ambient temperature does not exceed 50°C.

### 2-11 Outline Diagram

2-12 Figure 2-1 illustrates the two basic outline shapes for power supplies of the SCR-10 Series.

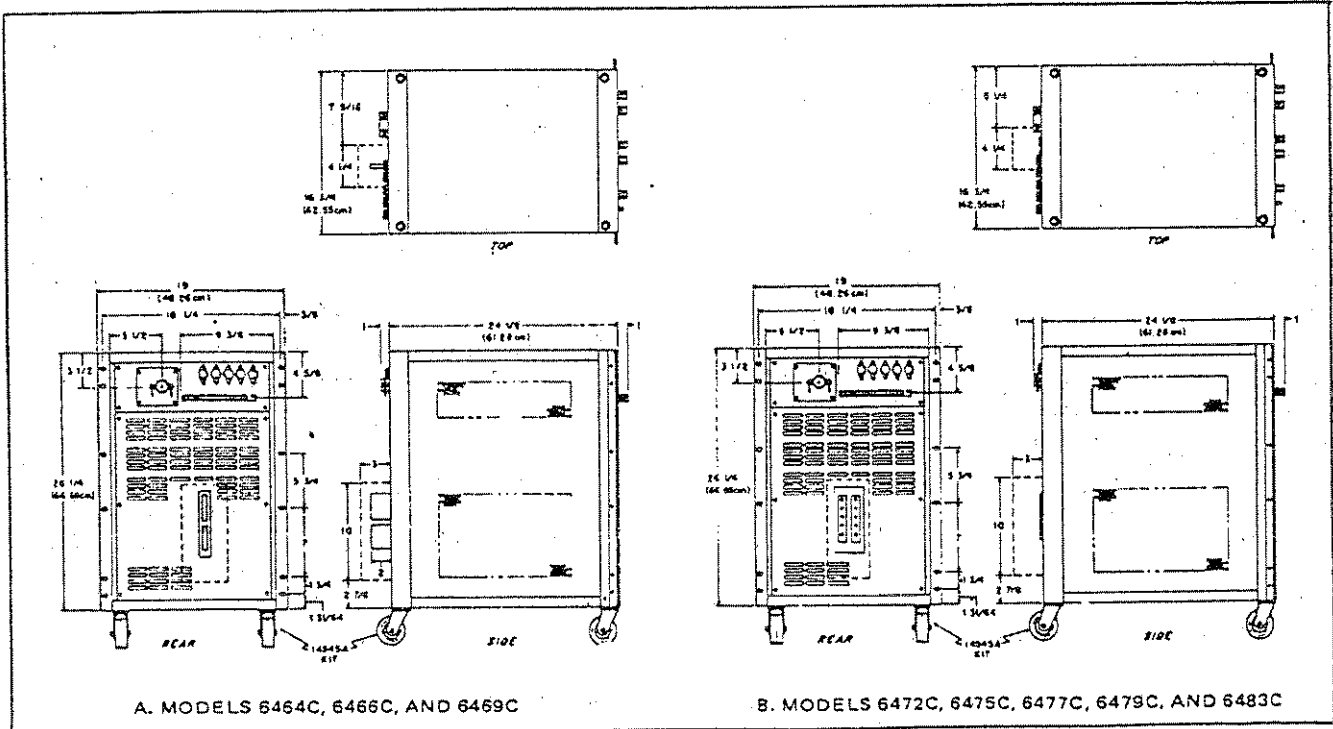

Figure 2-1. Outline Diagram

## 2-13 Rack Mounting

2-14 To rack mount the unit, Option 023 is installed at the factory. The user receives the supply with rack ears attached to the side-front of the unit. The supply can then be mounted in a standard 19-inch rack using standard mounting screws.

## 2-15 INPUT POWER REQUIREMENTS

2-16 The input power is specified by the buyer in his original purchase contract using the appropriate option number. Five input options are available; Option 001 (208Vac), 002 (230Vac), 003 (460Vac), 031 (380Vac) and 032 (400Vac). All of the optional line voltages may vary within  $\pm 10\%$ .

2-17 All ac input connections are made at the rear terminal block (a power cord and connector are not supplied with the unit). The user should ensure that the ac input wires are of the proper gauge. For example, the line current is 50 amperes (maximum) for a 230Vac input, dictating that each conductor be at least number 8 gauge wire. The safety ground wire should be the same gauge as the ac input wires to ensure that it does not open and create a safety hazard.

2-18 The ac power source to this supply may be either delta or wye with isolated neutral. The three phase input voltages must be balanced to within 8% of each other for the supply to operate. However, if the input line voltages are unbalanced by more than 3%, the unit may not meet the published ripple and noise specification; although it will meet all other specifications. Moreover, if the user's line imbalance exceeds 3%, it is advisable to check the input line currents and adjust the current balance circuit, if necessary (refer to Paragraph 5-95).

2-19 Any SCR regulated supply, because of its inherent characteristics, cannot tolerate a great degree of distortion in the input line voltage. The amount of distortion that can be tolerated is not precisely defined, but the supply should never be driven from the output of an inverter or a saturable-reactor type of regulator where the nominally sinusoidal waveshape is flattened considerably. Another cause of distortion is high line impedance. The user should contact the factory if trouble is experienced in this area.

## 2-20 208/230Vac Conversion

2-21 To convert the unit from a 208Vac (Option 001) to a 230Vac (Option 002) input, or vice versa, it is necessary only to restrap transformers T4, T5, and A3T1, T2, and T3. No other changes are necessary because the components used for Options 001 and 002 are identical. The schematic diagram, Figure 7-7, shows the transformers noted above

strapped for 230Vac operation. Hence, to convert the unit from a 208Vac input to a 230Vac input, remove the 208V ac jumpers and connect the transformers as shown on the schematic. To convert the unit from a 230Vac input to a 208Vac input, simply use the 208V terminals as follows:

a. With the unit off, remove jumper between T5-3 and T5-6. Connect new jumper between T5-2 and T5-5. Disconnect wire from fuse F8 to T5-6 and connect it between F8 and T5-5.

b. For transformer T4, remove three straps between A1-230, B1-230, and C1-230 and connect a strap between A1-208, B1-208, and C1-208.

c. On transformers A3T1, A3T2, and A3T3, disconnect three jumpers between T1-0V and T2-230, T2-0V and T3-230, and T3-0V and T1-230. Connect three jumpers as follows: T1-0V to T2-208, T2-0V to T3-208, and T3-0V to T1-208.

## 2-22 380/400Vac Conversion

2-23 To convert the unit from a 380Vac (Option 031) to a 400Vac (Option 032) input, or vice versa, it is necessary only to restrap transformers T4, T5, and A3T1, T2, and T3. No other changes are necessary because the components used for Options 031 and 032 are identical.

2-24 Transformer Connections for 380Vac Input. For a 380Vac input, the 0V tap on the primary transformer T5 is connected to fuse F7 and the 380V tap is connected to fuse F8. The 400V tap is open. The secondary windings are connected as shown on the schematic, Figure 7-7.

2-25 Transformer T4 is connected in the delta-star configuration shown on Figure 7-7. For 380Vac operation, connect tap A1 to tap 380 on the B section, tap B1 to tap 380 of the C section, and tap C1 to tap 380 of the A section. The three 400V taps are open.

2-26 Transformers A3T1, A3T2 and A3T3 are connected in the delta-delta configuration shown on Figure 7-7. For 380Vac operation, connect T1-0V to T2-380V, T2-0V to T3-380 and T3-0V to T1-380V. The 400 taps on the three transformers are open.

2-27 Transformer Connections for 400Vac Input. For a 400Vac input, the 0V tap on the primary of T5 must be connected to fuse F7 and the 400V tap must be connected to fuse F8. The 380V tap is left open. Secondary taps remain connected as shown on Figure 7-7.

2-28 For transformer T4 (delta-star configuration) tap A1 is connected to tap 400 on the B section, tap B1 is connected to tap 400 on the C section, and tap C1 to tap 400 on the A section. The three 380V taps are left open.

2-29 Transformers A3T1, A3T2, and A3T3 are connected in an delta-delta configuration as follows: T1-0V to T2-400V, T2-0V to T3-400V and T3-0V to T1-400V. The 380V taps on the three transformers are left open.

### 2-30 50Hz Ac Input (Option 005)

2-31 For operation from a 50Hz source it is necessary only to readjust the output ripple as described in Paragraph 5-94. In rare instances it may be necessary to readjust the transient recovery potentiometer (A1R48) if the supply shows signs of oscillating.

### 2-32 REPACKAGING FOR SHIPMENT

2-33 To insure safe shipment of the instrument, it is recommended that the package designed for the instrument be used. The original packaging material is reusable. If it is not available, contact your local Hewlett-Packard field office to obtain the materials. This office will also furnish the address of the nearest service center to which the instrument can be shipped. Be sure to attach a tag to the instrument specifying the owner, model number, full serial number, and service required, or a brief description of the trouble.

## SECTION III OPERATING INSTRUCTIONS

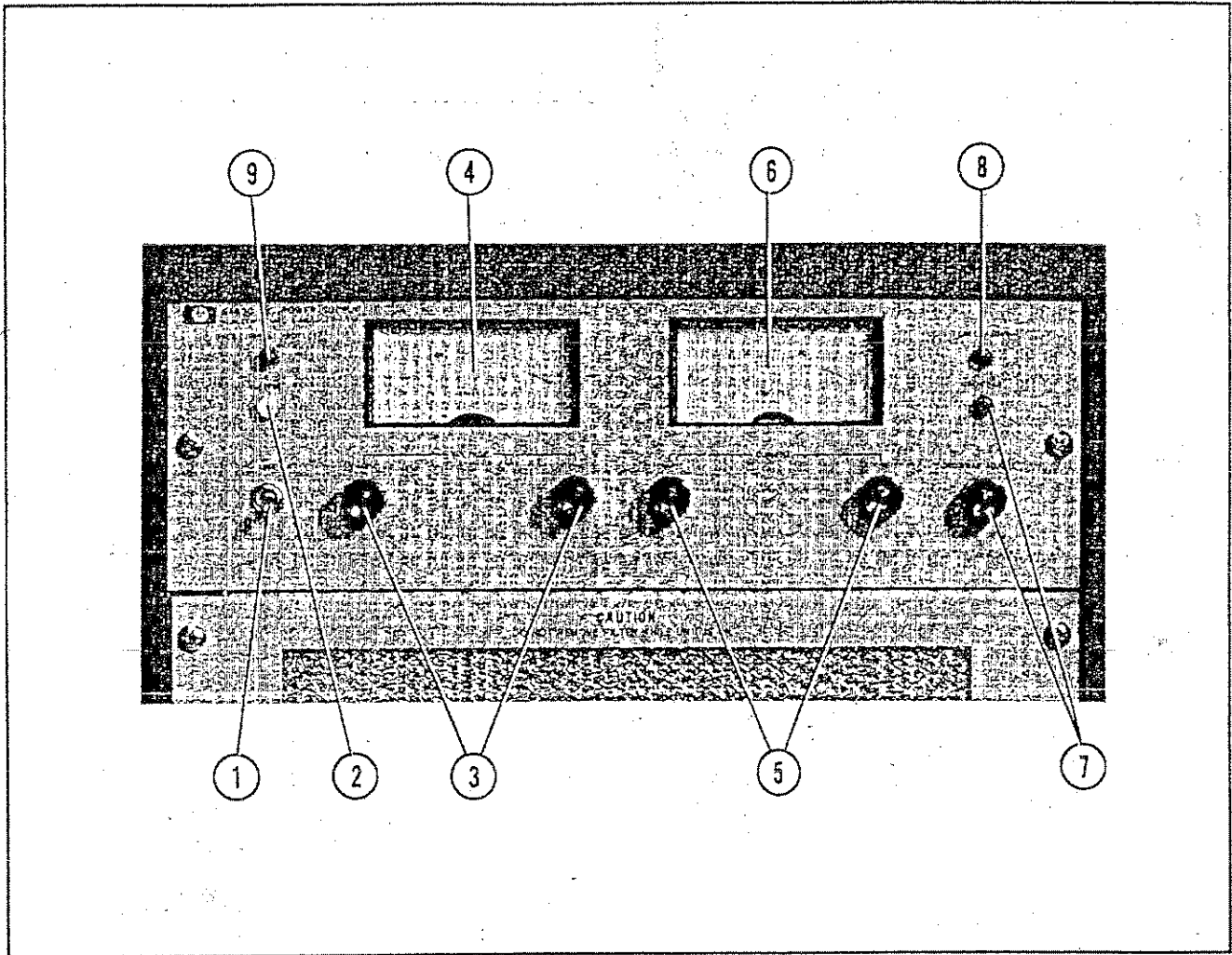

Figure 3-1. Front Panel Controls and Indicators, Typical SCR-10 Supply

### 3-1 TURN-ON CHECKOUT PROCEDURE

3-2 The following checkout procedure describes the use of the front panel controls and indicators (Figure 3-1) and ensures that the supply is operational.

a. Set  $\sim$ LINE ON switch (1) to on and observe that pilot lamp (2) lights.

b. After turn-on delay period (see NOTE), rotate CURRENT controls fully clockwise and adjust VOLTAGE controls (3) to obtain desired output voltage on voltmeter (4).

### NOTE

*The supply output is held off for approximately 10 to 20 seconds after turn-on by an internal control circuit.*

c. To check out constant current circuit, first *turn off supply*. Then, short circuit output bus bars and rotate VOLTAGE controls fully clockwise. Turn-on supply.

d. After turn-on delay, adjust CURRENT controls (5).



until desired output current is indicated on ammeter (6)

e. If supply is equipped with an overvoltage crowbar (Option 006), front panel will contain CROWBAR ADJUST pot and lamp (7). If Option 006 is not ordered this portion of panel is blank. Refer to Appendix A for crowbar operating instructions.

f. TEMPERATURE and OVERCURRENT PROTECT lamps, (8) and (9), are described in Paragraph 3-24. Before connecting actual load to supply, read the following paragraphs.

### 3-3 OPERATING MODES

3-4 The power supply is designed so that its mode of operation can be selected by making strapping connections between particular terminals on the terminal strips at the rear of the power supply. The terminal designations are plated on the P.C. board below their respective terminals. The following paragraphs describe the procedures for utilizing the various operational capabilities of the power supply. A more theoretical description concerning the operational features of this supply is contained in Application Note 90A, Power Supply Handbook (available at no charge from your local Hewlett-Packard sales office). Sales office addresses appear at the rear of the manual.

### 3-5 NORMAL OPERATING MODE

3-6 The power supply is normally shipped with its rear terminal strapping connections arranged for constant voltage/constant current, local sensing, local programming, single unit mode of operation. This strapping pattern is shown in Figure 3-2. The operator selects either a constant voltage or a constant current output using the front panel controls (local programming; no strapping changes are necessary).

### 3-7 Constant Voltage

3-8 To select a constant voltage output, proceed as follows:

- Turn on power supply and adjust VOLTAGE controls for desired output voltage with output terminals open.
- Short circuit output terminals and adjust CURRENT controls for maximum output current allowable (current limit), as determined by load conditions. If a load change causes the current limit to be exceeded, the power supply will automatically cross over to constant current output at the preset current limit and the output voltage will drop proportionately. In setting the current limit, allowance must be made for high peak currents which can cause unwanted crossover. (Refer to Paragraph 3-63.)

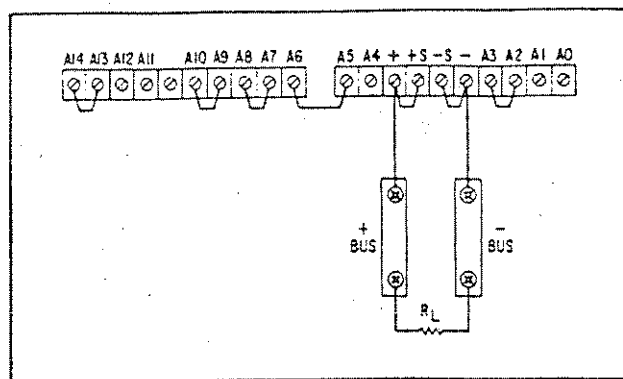

Figure 3-2. Normal Strapping Pattern

### 3-9 Constant Current

3-10 To select a constant current output, proceed as follows:

- Short circuit output terminals and adjust CURRENT controls for desired output current.
- Open output terminals and adjust VOLTAGE controls for maximum output voltage allowable (voltage limit), as determined by load conditions. If a load change causes the voltage limit to be exceeded, the power supply will automatically cross over to constant voltage output at the preset voltage limit and the output current will drop proportionately. In setting the voltage limit, allowance must be made for high peak voltages which can cause unwanted crossover. (Refer to Paragraph 3-63.)

### NOTE

As indicated on the Specification Table (1-1) the supply may not meet all specifications under "light load" conditions. These constraints are due to minimum operating thresholds inherent in the SCR's in the regulator. However, as shown on Table 1-1, the supply will operate satisfactorily if the supply delivers more than 30% of the rated output voltage (Constant Voltage operation) or rated output current (Constant Current operation). Only 5% of rated output voltage or current is required provided that the supply is delivering more than 100 Watts to the load.

### 3-11 No Load Operation

3-12 When the supply is operated without a load, down-programming speed is considerably slower than in normal loaded operation. The actual time required for the output voltage to decrease to a level set by the front panel control varies from approximately 6 seconds to about 200 seconds, depending on the model number and the incremental change.

### 3-13 Output Ranges — Models 6466C and 6483C Only

3-14 Model 6466C can be operated in one of two output ranges while Model 6483C has three output ranges (refer to Specification Table, 1-1, for these units). No range switching is required but the current and voltage requirements of the load should be predetermined to ensure that the ratings for a particular range will not be exceeded. If a rating is exceeded, one of the supply's internal protection circuits will be activated. For example, if the supply is operating in the high voltage, low current range and the output current exceeds the rating for that range, the overcurrent circuit will become activated and shut off the supply.

### 3-15 Connecting Load

3-16 Each load should be connected to the power supply output terminals using separate pairs of connecting wires. This will minimize mutual coupling effects between loads and will retain full advantage of the low output impedance of the power supply. Each pair of connecting wires should be as short as possible and twisted or shielded to reduce noise pickup. (If a shielded pair is used, connect one end of the shield to ground at the power supply and leave the other end unconnected.)

3-17 If load considerations require that the output power distribution terminals be remotely located from the power supply, then the power supply output terminals should be connected to the remote distribution terminals via a pair of twisted or shielded wires and each load should be separately connected to the remote distribution terminals. For this case, remote sensing should be used. (Refer to Paragraph 3-40.)

### 3-18 Grounding

3-19 Positive or negative output voltages can be obtained from the supply by grounding either output bus. If the output is floated (neither output bus grounded) it can be operated up to 100Vdc above ground (300Vdc above ground for Models 6475C, 6477C, and 6479C).

3-20 When grounding the output, the customer's ground must be used and connected to the desired output bus on the supply. *Do not ground the output at the supply's chassis or at the ac ground terminal on the rear of the supply.* These points are at safety ground and are not the neutral of the power source (refer to Section II). By following these recommendations and running a separate lead from each output bus to the load, the user will be doubly certain that no load current will flow through the ac input wires to the supply.

### 3-21 Operation Beyond Rated Output

3-22 The shaded area on the front panel meter face indicates the approximate amount of output voltage or current that may be available in excess of the normal rated output. Although the supply can be operated in this shaded region without being damaged, it cannot be guaranteed to meet all of its performance specifications.

### 3-23 Protection Circuits

3-24 This supply contains an internal overload protection circuit which shuts off the supply in the event of a prolonged overcurrent or overtemperature condition (details given in Section IV). This circuit also illuminates the applicable indicator lamp (OVERCURRENT PROTECT or TEMPERATURE) on the front panel. If one of these lamps should light, the operator should set the LINE switch to off and turn the VOLTAGE and CURRENT controls to zero (CCW). Next, the unit should be turned back on. If the overload lamp lights again, turn the unit off and proceed to Section V, Troubleshooting. If the lamp does not light, the overload may have been caused by a line transient or an improper connection at the rear barrier strip. Ensure that all screws on the rear barrier strip are tight and that the strapping pattern agrees with the desired operation.

### 3-25 OPTIONAL OPERATING MODES

#### 3-26 Remote Programming, Constant Voltage

3-27 The constant voltage output of the power supply can be programmed (controlled) from a remote location if required. Either a resistance or voltage source can be used as the programming device. The wires connecting the programming terminals of the supply to the remote programming device should be twisted or shielded to reduce noise pickup. The VOLTAGE controls on the front panel are automatically disabled by the following procedures.

3-28 Resistance Programming (Figure 3-3). In this mode,

the output voltage will vary at a rate determined by the constant voltage programming coefficient (refer to Specifications Table, 1-1). The programming coefficient is determined by the programming current. This current is factory adjusted to within 1%. If greater programming accuracy is required, it may be achieved by adjusting A1R9 as discussed in Paragraph 5-76.

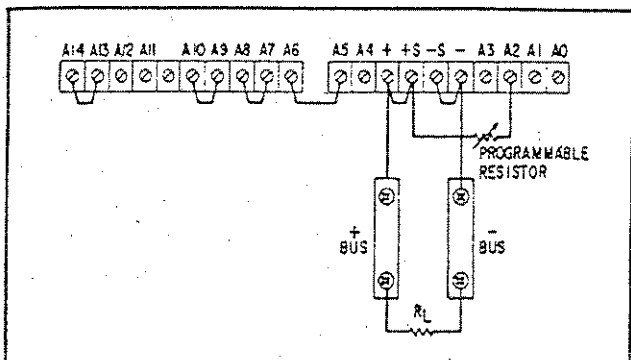

Figure 3-3. Remote Resistance Programming, Constant Voltage

3-29 The output voltage of the supply should be  $0 \pm 10\text{mV}$  when zero ohms is connected across the programming terminals. If a zero ohm voltage closer to zero than this is required, it may be achieved by inserting and adjusting A1R11 as discussed in Paragraph 5-75.

3-30 To maintain the stability and temperature coefficient of the power supply, use programming resistors that have stable, low noise, and low temperature coefficient (less than 30ppm per degree Centigrade) characteristics. A switch can be used in conjunction with various resistance values in order to obtain discrete output voltages. The switch should have make-before-break contacts to avoid momentarily opening the programming terminals during the switching interval.

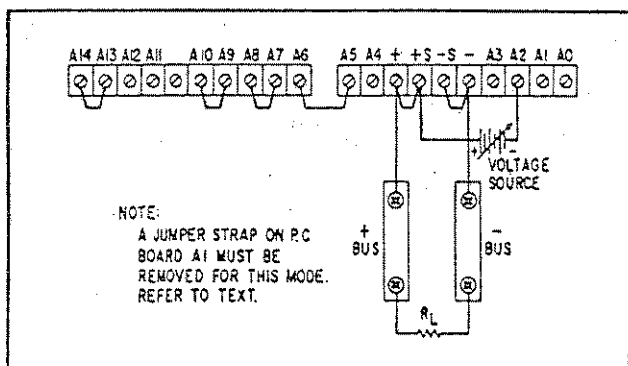

Figure 3-4. Remote Resistance Programming, Constant Voltage, Unity Gain

3-31 Voltage Programming, Unity Gain (Figure 3-4). Employ the strapping pattern shown in Figure 3-4 for voltage programming with unity gain. In this mode, the output voltage will vary in a 1 to 1 ratio with the programming voltage (reference voltage) and the load on the programming voltage source will not exceed 20 microamperes.

3-32 To prevent the internal programming current from flowing to terminal A2 and into the external voltage source, a jumper strap on P.C. Board A1 must be removed (see Figure 7-1 for location of the jumper). Be sure to reconnect this jumper before converting the unit to a different operating mode.

3-33 The output voltage of this supply *cannot* be voltage programmed with gain unlike some of the other HP supplies.

3-34 Remote Programming, Constant Current

3-35 Either a resistance or a voltage source can be used to control the constant current output of the supply. The CURRENT controls on the front panel are automatically disabled by the following procedures.

3-36 Resistance Programming (Figure 3-5). In this mode, the output current varies at a rate determined by the constant current programming coefficient given in Specifications Table, 1-1. The programming coefficient is determined by the constant current programming current which is adjusted to within 2% at the factory. If greater programming accuracy is required, it may be achieved by adjusting A1R25 as discussed in Paragraph 5-83. The output current of the supply when zero ohms is placed across the programming terminals may be set to exactly zero by adjusting A1R28 as discussed in Paragraph 5-82.

3-37 Use stable, low noise, low temperature coefficient (less than 30ppm/°C) programming resistors to maintain the power supply temperature coefficient and stability

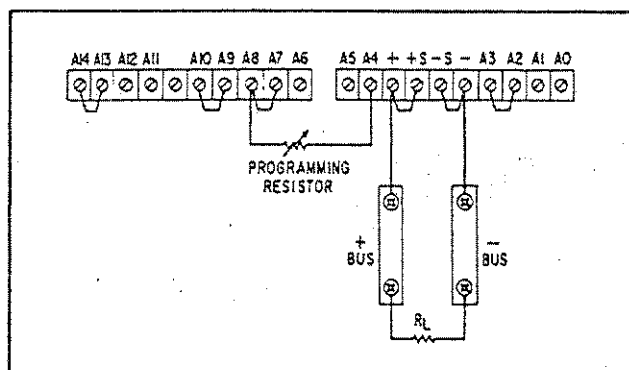

Figure 3-5. Remote Resistance Programming, Constant Current

specifications. A switch may be used to set discrete values of output current. A make-before-break type of switch should be used since the output current will exceed the maximum rating of the power supply if the switch contacts open during the switching interval.

**CAUTION**

*If the programming terminals (A4 and A8) should open at any time during the remote resistance programming mode, the output current will rise to a value that may damage the load. If, in the particular programming configuration in use, there is a chance that the terminals might become open, it is suggested that a 1kΩ resistor be connected across the programming terminals. Like the programming resistor, this resistor should be a low noise, low temperature coefficient type. Note that when this resistor is used, the resistance value actually programming the supply is the parallel combination of the remote programming resistance and the resistor across the programming terminals.*

3-38 Voltage Programming With Gain (Figure 3-6). The power supply output current can be programmed using an external voltage source with variable gain by utilizing the strapping pattern shown in Figure 3-6. In this mode, the output current will vary linearly from 0 to maximum rating when the voltage source is programmed from 0 to 6.2 volts. The value of the voltage source appearing across terminals A9 and A10 should not exceed 7.4Vdc if possible damage to the instrument is to be avoided.

3-39 External resistor  $R_p$  should have stable, low noise, and low temperature coefficient (less than 30ppm per degree Centigrade) characteristics in order to maintain the stability and temperature specifications of the power supply.

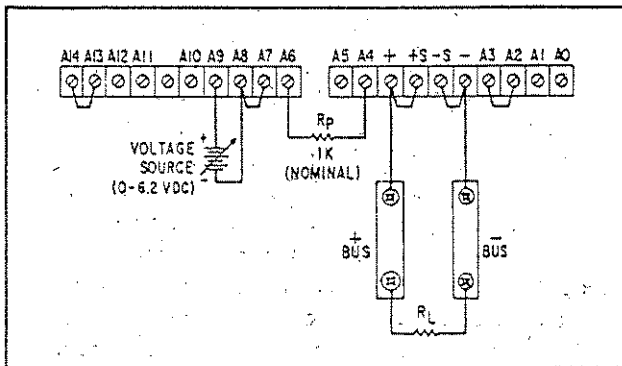

Figure 3-6. Remote Voltage Programming, Non-Unity Gain, Constant Current

Note that it is possible to use the front panel current controls already in the supply ( $R_3$  and  $R_4$ ) as the *gain* control ( $R_p$ ) by simply removing the *external*  $R_p$  and strapping terminals A5 and A6 together.

3-40 Remote Sensing (Figure 3-7)

3-41 Remote sensing is used to maintain good regulation at the load and reduce the degradation of regulation which would occur due to the voltage drop in the leads between the power supply and the load. Remote sensing is accomplished by utilizing the strapping pattern shown in Figure 3-7. The power supply should be turned off before changing strapping patterns. The leads from the sensing ( $\pm S$ ) terminals to the load will carry much less current than the load leads and it is not required that these leads be as heavy as the load leads. However, they must be twisted or shielded to minimize noise pickup.

3-42 For reasonable load lead lengths, remote sensing greatly improves the performance of the supply. However, if the load is located a considerable distance from the supply, added precautions must be observed to obtain satisfactory operation. Notice that the voltage drop in the load leads subtracts directly from the available output voltage and also reduces the amplitude of the feedback error signals that are developed within the unit. Because of these factors it is recommended that the drop in the negative load lead not exceed 3 volts. If a larger drop must be tolerated, please consult an HP Sales Engineer.

**NOTE**

*Due to the voltage drop in the load leads, it may be necessary to readjust the current limit in the remote sensing mode.*

3-43 Observance of the precautions in Paragraph 3-42 will result in a low dc output impedance at the load. However,

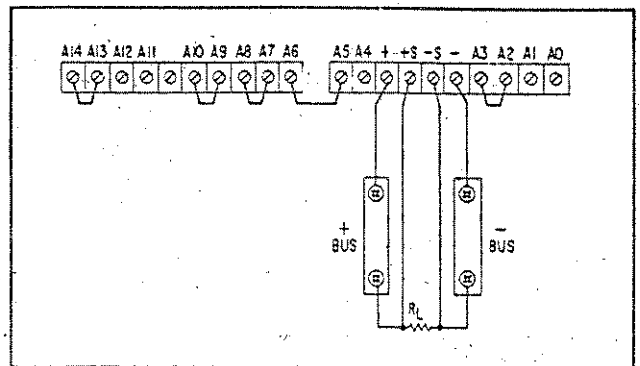

Figure 3-7. Remote Sensing

another factor that must be considered is the inductance of long load leads. This causes a high ac impedance and could affect the stability of the feedback loop seriously enough to cause oscillation. If this is the case, it is recommended that the following actions be taken:

- a. Adjust equalization control A1R48 to remove oscillation, or to achieve best possible transient response for given long load lead configuration. Refer to Paragraph 5-88 for discussion of transient response measurement.
- b. If performing adjustment in step (a) above does not remove oscillation, connect a capacitor having similar characteristics to those of the output capacitors (C1, C2, etc.) used in the supply, directly across load using short leads. Readjust equalization control R48 as in step (a) above after making this change.

3-44 Although the strapping patterns shown in Figures 3-3 through 3-6 employ local sensing, it is possible to operate a power supply simultaneously in the remote sensing and remote programming modes.

### 3-45 Auto-Parallel Operation (Figure 3-8)

3-46 Two (maximum) SCR-10 power supplies can be connected in an Auto-Parallel arrangement to obtain an output current greater than that available from one supply. Auto-Parallel operation permits equal current sharing under all load conditions, and allows complete control of the output current from the master power supply. The output current

of the slave will be approximately equal to the master's output current regardless of the load conditions. Because the output current controls of the slave are operative, they should be set to maximum to prevent the slave reverting to constant current operation; this would occur if the master output current setting exceeded the slave's.

3-47 Remote sensing and programming can be used, though the strapping arrangements shown in Figure 3-8 show local sensing and programming.

### 3-48 Auto-Series Operation (Figure 3-9)

3-49 Two (maximum) SCR-10 power supplies can be operated in Auto-Series to obtain a higher voltage than that available from a single supply. When this connection is used, the output voltage of the slave supply varies in accordance with that of the master supply. At maximum output voltage, the voltage of the slave is determined by the setting of the front panel VOLTAGE controls on the master. The master supply must be the most positive supply of the series. The output CURRENT controls of the slave unit are operative and the current limit is equal to the lowest control setting. If any of the output CURRENT controls are set too low, automatic crossover to constant current operation will occur and the output voltage will drop. Remote sensing and programming can be used, though the strapping arrangements shown in Figure 3-9 show local sensing and programming.

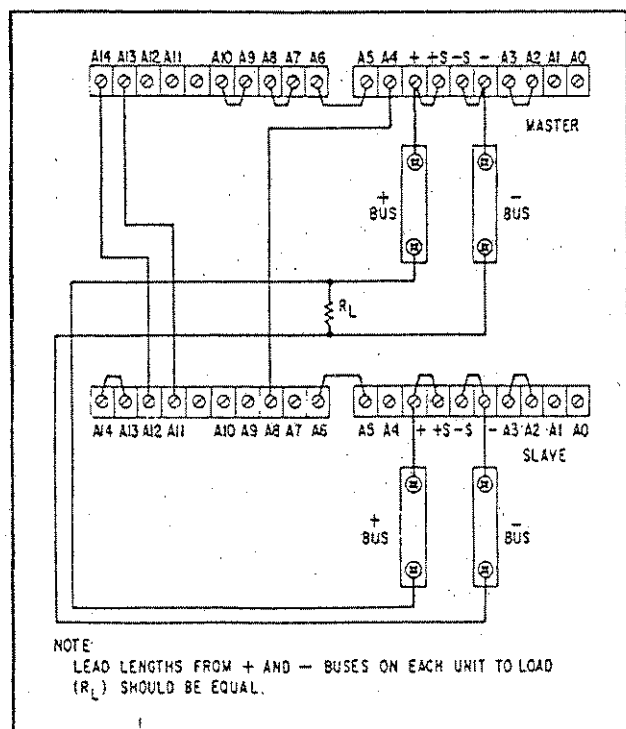

Figure 3-8. Auto-Parallel Operation

### CAUTION

*Model 6483C, of the SCR-10 Series, cannot be operated in Auto-Series because this supply can not be floated at more than 100Vdc off ground. However, "Auto-Tracking" can be utilized to obtain coordinated positive and negative voltages if the center tap of the combination is grounded (refer to Paragraph 3-52).*

3-50 In order to maintain the temperature coefficient and stability specifications of the power supply, the external resistors ( $R_X$ ) shown in Figure 3-9 should be stable, low noise, low temperature coefficient (less than 30ppm per degree Centigrade) resistors. The value of each resistor is dependent on the maximum voltage rating of the "master" supply. The value of  $R_X$  is this voltage divided by the Constant Voltage programming current of the slave supply ( $1/K_p$  where  $K_p$  is the resistance programming coefficient). The voltage contribution of the slave is determined by its voltage control setting.

3-51 Protection diodes (CR5), connected across the output





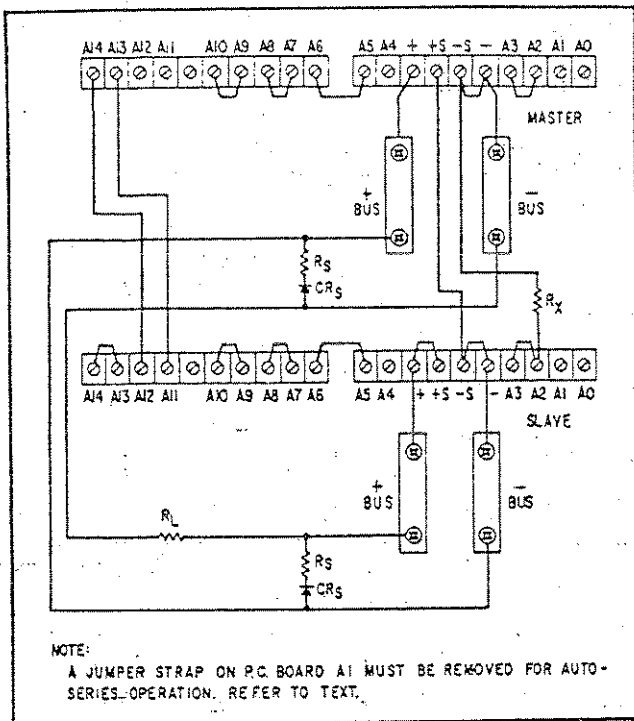

Figure 3-9. Auto-Series Operation

of each supply, prevent internal damages that could occur from reverse voltages if one supply is turned on before the other. On six models in the SCR-10 Series, current limiting resistors are required. Values and part numbers for the resistors and diodes are given in the chart below.

Model	CRS Commercial/HP Part No.	RS Value
6464C	A295F/1901-0336	Not required
6466C	A90F/1901-0335	Not required
6469C	A90A/1901-0338	0.02Ω
6472C	1N3289/1901-0307	0.03Ω
6475C	1N1187A/1901-0320	0.08Ω
6477C	S3270/1901-0326	0.20Ω
6479C	S3270/1901-0326	0.25Ω
6483C	S3270/1901-0326	0.75Ω

3-52 When the center tap of an Auto-Series combination is grounded, coordinated positive and negative voltages result. This technique is commonly referred to as "rubber-banding" and an external reference source may be employed if desired. Any change of the internal or external reference source (e.g., drift, ripple) will cause an equal percentage change in the outputs of both the master and slave supplies. This feature can be of considerable use in analog computer and other applications, where the load requires a positive and a negative power supply and is less susceptible to an output voltage change occurring simultaneously in both supplies than to a change in either supply alone.

### 3-53 Battery Charging

3-54 The automatic crossover between constant voltage and constant current displayed by the SCR-10 Series makes it an ideal supply for battery charging applications. Using this feature, a battery may be charged at a constant current until the maximum charge voltage is reached at which point the supply will revert to constant voltage and continue to supply a trickle charge current sufficient to maintain full charge (see Figure 3-10). Thus, the charging operation can be unattended after properly setting the charging rate and the maximum charge voltage and connecting the battery to the output terminals of the supply.

3-55 The procedure for setting the charging rate and full charge voltage on SCR-10 Series power supplies is as follows:

- Turn both the VOLTAGE and CURRENT controls fully counterclockwise (CCW).
- Place a short circuit across the output terminals and rotate the VOLTAGE control fully clockwise (CW).
- Rotate the CURRENT control to the desired charging rate as read on the front panel ammeter.
- Rotate VOLTAGE control fully CCW and remove the short circuit.
- Rotate the VOLTAGE control to the desired full charge voltage as read on either the front panel voltmeter (2% accuracy) or a more precise voltage standard. The unit may then be connected to the battery terminals, positive to positive and negative to negative.

3-56 Protection diode CR<sub>p</sub> prevents a charged battery from discharging into the supply if the supply is turned off.

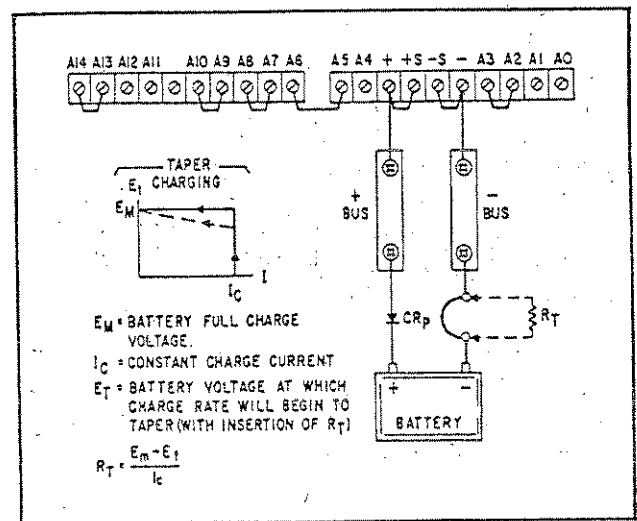

Figure 3-10. Battery Charging



## NOTE

A large battery, connected as a load, presents a large capacitance across the output terminals. This capacitance could cause the supply to oscillate; particularly if remote sensing is employed. To stabilize the supply, potentiometer A1R48 may be readjusted (increase resistance) as outlined in Paragraph 5-88. If the maximum resistance of R48 is not sufficient, jumper (R58) can be removed and an additional resistance substituted in series with the potentiometer.

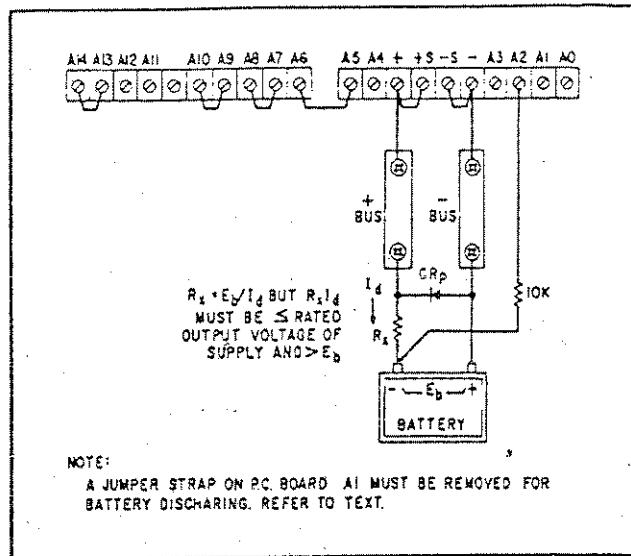

Figure 3-11. Battery Discharging

**3-57 Taper Charge.** For charging lead-acid cells, the charging current should be reduced when the battery is nearing completion of its charge. This is accomplished by inserting a small resistance ( $R_T$ ) in series with one of the load leads from the supply to the battery which alters the normally rectangular charging plot in such a manner as to provide a taper charge for the last portion of the charge cycle. The value of this resistance is the difference between the full charge voltage and the voltage at which the tapering is to start, divided by the maximum charging current.

### 3-58 Battery Discharging

**3-59 Automatic constant current, unattended discharging** of a battery using the SCR-10 Series requires certain changes in the strapping configuration on the rear barrier strip as illustrated in Figure 3-11. Also, a jumper strap on P.C. Board A1 must be removed (see Figure 7-1 for location). Removal of this jumper ensures that the internal programming current does not flow into terminal A2. Before operation, the user should make sure that the interconnecting leads between supply and battery are secure and cannot become opened.

**3-60** The supply initially operates in constant current mode at the value set by the current control. When the battery voltage is high the supply output voltage will be low, and as the battery discharges the supply output voltage increases. A constant voltage is maintained across  $R_X$  (constant current through  $R_X$ ). This condition will prevail until the battery voltage drops to zero. At this point, the supply will switch off and no more current will flow through  $R_X$ . Diode CRp protects the supply against reverse voltages. As shown on Figure 3-11,  $R_X$  must be selected so that its IR drop is less than the maximum rated output of the supply yet greater than the battery voltage.

**3-61** The procedure for the connection of the components in this configuration is as follows:

- Turn off the power supply and rotate the current control full counterclockwise. (The voltage control will be disconnected by step b.)
- Remove the designated jumpers (A2 to A3 and P.C. Board) and connect A2 to the negative terminal of the battery through 10k-resistor.
- Connect the negative terminal of the supply to the positive terminal of the battery.
- Insert  $R_X$  between the positive terminal of the supply and the negative terminal of the battery, energize the supply and rotate the current control to the desired discharge current as read on the front panel meter.

### 3-62 SPECIAL OPERATING CONSIDERATIONS

#### 3-63 Pulse Loading

**3-64** The power supply will automatically cross over from constant voltage to constant current operation, or the reverse, in response to an increase (over the preset limit) in the output current or voltage, respectively. Although the preset limit may be set higher than the average output current or voltage, high peak currents or voltages (as occur in pulse loading) may exceed the preset limit and cause crossover to occur. If this crossover limiting is not desired, set the preset limit for the peak requirement and not the average.



controlling the SCR firings originate within the constant voltage or constant current comparator. (The SCR's are also controlled by the current balance circuit and, in certain instances, by various protection circuits, as will be explained subsequently.) During constant voltage operation, the constant voltage comparator continuously compares the output voltage of the supply with the drop across the VOLTAGE controls. If these voltages are not equal, the comparator produces an amplified error signal which is further amplified by the error amplifier and fed back to the firing circuits. On the basis of the amplitude and polarity of the feedback signal, the firing circuits then issue a phase adjusted firing pulse to each SCR so that the original difference is counteracted. In this manner, the constant voltage comparator helps to maintain a constant output voltage and also generates the error signals necessary to set the output voltage at the level established by the VOLTAGE controls.

4-5 During constant current operation, the constant current comparator detects any difference between the voltage drop developed by the load current flowing through the current sampling resistor and the voltage across the CURRENT controls. If the two inputs to the comparator are momentarily unequal, an error signal is generated which (after amplification) alters the firing angle of the SCR's by the amount necessary to reduce the error voltage at the comparator input to zero. Hence, the IR drop across the current sampling resistor, and therefore the output current, is maintained at a constant value.

4-6 Since the constant voltage comparator tends to achieve zero output impedance and alters the output current whenever the load resistance changes, while the constant current comparator causes the output impedance to be infinite and changes the output voltage in response to any load resistance change, it is obvious that the two comparison amplifiers can not operate simultaneously. For any given value of load resistance, the power supply must act either as a constant voltage source or as a constant current source — it cannot be both.

4-7 Figure 4-2 shows the output characteristic of a constant voltage/constant current power supply. With no load attached ( $R_L = \infty$ ),  $I_{OUT} = 0$ , and  $E_{OUT} = E_S$ , the front panel voltage control setting. When a load resistance is applied to the output terminals of the power supply, the output current increases, while the output voltage remains constant; point D thus represents a typical constant voltage operating point. Further decreases in load resistance are accompanied by further increases in  $I_{OUT}$  with no change in the output voltage until the output current reaches  $I_S$ , a value equal to the front panel current control setting. At this point the supply automatically changes its mode of operation and becomes a constant current source; still further decreases in the value of load resistance are accompanied by

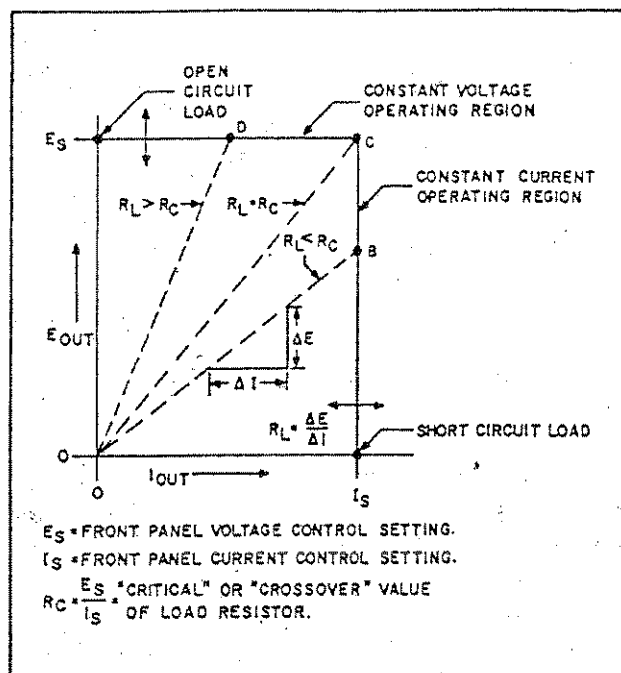

Figure 4-2. Operating Locus of a CV/CC Power Supply

a drop in the supply output voltage with no accompanying change in the output current value. With a short circuit across the output load terminals,  $I_{OUT} = I_S$  and  $E_{OUT} = 0$ .

4-8 The "crossover" value of load resistance can be defined as  $R_C = E_S / I_S$ . Adjustment of the front panel voltage and current controls permits this "crossover" resistance  $R_C$  to be set to any desired value from 0 to  $\infty$ . If  $R_L$  is greater than  $R_C$ , the supply is in constant voltage operation, while if  $R_L$  is less than  $R_C$ , the supply is in constant current operation.

#### 4-9 Current Balance Circuit

4-10 The current balance circuit maintains the rms amplitude of the input current flowing in the phase B and phase C lines equal to input current flowing in the phase A (reference) line. To accomplish this, the circuit compares the current in the phase B and C lines with that of the reference phase (A). If a difference exists, the current balance circuit issues an error signal to the firing circuits. The firing of the phase B or phase C SCR is then advanced or delayed in accordance with the polarity of the original difference signal. Hence, the current balance circuit allows the unit to operate with a line-to-line input voltage unbalance of up to 8%.

#### 4-11 Turn-On Control Circuit

4-12 The turn-on control circuit is a long time constant network which achieves a slow turn-on characteristic. This feature protects load devices by minimizing turn-on overshoot. At turn-on, the control circuit provides an inhibit

voltage to the firing circuits (via the error amplifier) keeping the SCR's off for approximately 20 seconds. After 20 seconds, the inhibit voltage is removed and the circuit no longer exercises any control over the operation of the supply.

#### 4-13 Overvoltage Protection Feature

4-14 The overvoltage protection circuit prevents the output voltage of the supply from exceeding 110% of rating. It monitors the output voltage of the supply and, if it exceeds the 110% threshold, sends a "hold" signal to the firing circuits. This circuit is seldom activated because the constant voltage comparator prevents the output voltage from exceeding the limit established by the front panel VOLTAGE controls. However, if the constant voltage comparator should fail, the overvoltage protection circuit provides the necessary backup protection.

#### 4-15 Overcurrent Protection Circuit

4-16 The overcurrent protection circuit provides backup protection for the constant current comparator being similar to the overvoltage protection circuit in this respect. The overcurrent circuit monitors the output current (IR drop across sampling resistor) and generates a "hold" signal to the SCR firing circuits if the output current attempts to exceed approximately 115% of rating.

#### 4-17 Early Overcurrent Protection Circuit

4-18 Further overcurrent protection is afforded by the early overcurrent protection circuit. This circuit minimizes output current overshoot during initial short circuit conditions. If the output of the supply is shorted, both the line current and the output current attempt to rise. The early overcurrent protection circuit monitors the line current (phases B and C) and generates a turn off signal to the SCR firing circuits if the line current exceeds about 40% of the nominal peak value. The three SCR's are then turned-off momentarily until the line current falls below the 40% threshold and the early overcurrent protection circuit is deactivated. At this time, the constant current comparator and remaining components of the feedback loop again assume control of the SCR's keeping the output current constant despite short circuit conditions.

4-19 Although the constant current comparator attempts to keep the output current from rising when the output is first shorted, it requires approximately 5 cycles of the input ac before a correction can be made. This delay is a result of the overall loop response time and is mostly caused by equalizing networks within the error amplifier. The early overcurrent circuit overcomes this delay by bypassing the error amplifier and injecting its turn-off signal directly into the firing circuits. With this arrangement, correction can begin after only one cycle of the input ac.

#### 4-20 Phase Protection Circuit

4-21 Another protection circuit used in this supply is the phase protection circuit. This circuit insures that no damage will occur internally should one or more of the input phases fail or if the ac voltage on all three input lines falls below 25% of the input rating. If such a failure does occur, the phase protection circuit clamps the feedback control signal off at the input to the error amplifier. When the input lines return to normal, the operation reverses itself.

#### 4-22 Overload Circuit

4-23 This circuit detects the presence of an extended overcurrent or an overtemperature condition and deenergizes contactor K2 if either of these conditions occur. With K2 deenergized, the 3-phase ac input path is interrupted shutting down the supply. Contactor K2 is also deenergized if the overload circuit receives a "trip" input from the overvoltage crowbar (optional circuit).

4-24 The overload circuit continuously monitors the line current on phases B and C and deenergizes K2 if the line current exceeds approximately 40% of the nominal rms line rating of the unit for a period of about one second. The overload circuit also illuminates the OVERCURRENT PROTECT lamp on the front panel under these conditions. During normal operation of the supply, the early overcurrent protection circuit and/or the constant current feedback loop will compensate for overcurrent problems before the overload circuit ever becomes activated. However, should a failure occur within these overcurrent protection circuits, the overload circuit would then become activated deenergizing K2 and shutting off the supply.

4-25 A thermal switch, mounted on the SCR heat sink, provides overtemperature protection by opening if the heat sink temperature rises to  $200^{\circ} \pm 6^{\circ}\text{F}$  (208Vac or 230Vac input) or  $170^{\circ} \pm 5^{\circ}\text{F}$  (380Vac, 400Vac, or 460Vac input). Opening the thermal switch deenergizes contactor K2 and removes the short across the TEMPERATURE lamp, allowing it to light.

#### 4-26 Reference Supply

4-27 The reference supply provides regulated bias voltages which are used by the internal circuitry throughout the main power supply. All of the voltages shown are regulated except for the -24V.

#### 4-28 Overvoltage Crowbar (Optional Circuit — not available for Model 6464C)

4-29 A built-in overvoltage "crowbar" protection circuit (Option 006) can be ordered with any power supply in the

SCR-10 Series with the exception of Model 6464C. This circuit monitors the output voltage of the supply and fires an SCR if the output voltage exceeds a preset and adjustable threshold. The conducting SCR effectively short circuits the supply reducing the output to near zero volts. Complete details concerning the Option 006 crowbar circuit are given in Appendix A.

#### 4-30 DETAILED CIRCUIT ANALYSIS (See Schematic, Figure 7-7)

#### 4-31 SCR Regulator and Firing Circuits

4-32 The SCR regulator, operating in conjunction with the firing circuits, controls the amount of ac power applied to the primary of the power transformer. Each of the three input phases (arbitrarily designated A, B, and C) has an SCR and firing circuit associated with it.

4-33 Each SCR conducts upon the simultaneous application of a negative voltage to its cathode (input ac) and a positive voltage to its gate lead. The gate signal (firing pulse) used to turn on the SCR is a positive going pulse of about 3.5 volts having a duration of approximately 50 $\mu$ sec. Once the SCR is fired, it remains in conduction (even though the gate input is removed) until the input ac swings positive.

4-34 Inductors L1, L2, and L3 limit surge currents due to the conduction of their respective SCR's. A capacitive network, connected across each SCR, filters voltage transients caused by contactor K2 when it is energized or deenergized. Also connected across each SCR is a diode (CR1-CR3) which protects the SCR against reverse voltages and also serves as the return path for the current from one of the other phases.

4-35 Firing Circuits. The three phase firing circuits receive the output from the error amplifier and generate firing pulses that turn on the SCR's in their respective phases at the precise time necessary to fulfill the feedback loop requirements. As indicated on the schematic, everything is done in triplicate. For each phase there is a blocking oscillator which is synchronized so that each SCR conducts at identically the same phase angle in its respective phase.

4-36 The input to the firing circuits is the feedback voltage from error amplifier A1U3. This voltage varies between -1V dc to +3Vdc (with respect to common  $\nabla$  at terminal A7) as a function of the output conditions. The feedback voltage is applied to an integrating network (R7, C3-R17, C13 and R27, C23) in the emitter circuit of each blocking oscillator. The emitter capacitors produce a steadily rising ramp voltage whose origin is approximately -12.4V (see Figure 4-3). The waveform on the base of each blocking oscillator is mainly the result of internal generators A2R28, A2C4-

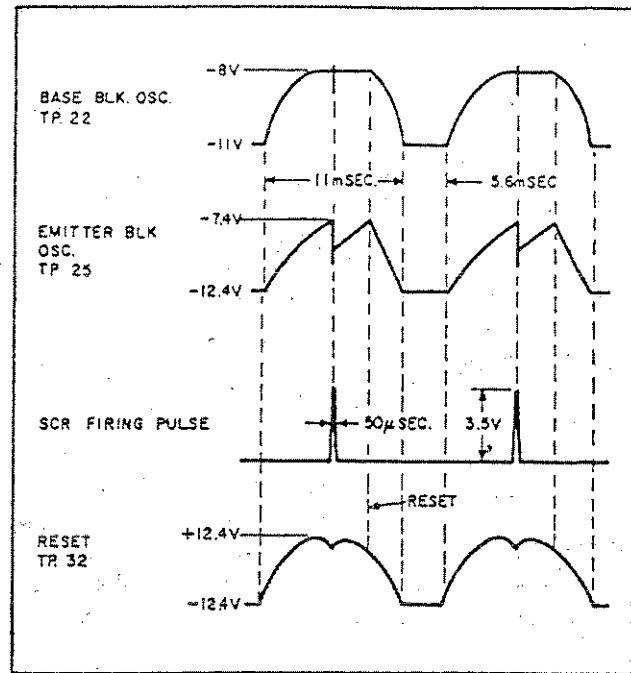

Figure 4-3. SCR Firing Circuit, Timing Diagram

A1R100, A2C14 and A1R120, A2C24 which produce an 11msec wide, rectangular shaped waveform. The 5.6msec wide negative portion is flattened by the action of clamping diodes CR6, CR16 and CR26. The positive going emitter voltage rises to meet the base voltage and when the base-emitter bias reaches about 0.6Vdc the applicable transistor (Q1, Q2, or Q3) becomes forward biased initiating blocking oscillator action. Regenerative coupling between the collector and base windings of each transformer (T7, T8, and T9) rapidly drives the transistor into full conduction where it remains (for about 50 $\mu$ sec) until the transformer becomes saturated. At this time, the collapsing magnetic field returns the blocking oscillator to the nonconducting state.

4-37 The firing pulses are taken from the output winding of each transformer and applied between the gate and cathode of the appropriate SCR. Diodes CR2, CR12 and CR22 connected across the output windings, are used to damp out negative overshoot. Resistors R1, R11 and R21 provide a bleed path for current flowing out of the SCR gate terminal, while diodes CR1, CR11 and CR21 block the voltage established by the gate current from reaching the output windings.

4-38 Capacitors C1, C11, and C21 between base and emitter of each blocking oscillator transistor prevent spurious triggering. The base current which flows when the transistors conduct is limited by resistors R3, R13, or R23 connected to each base winding.

4-39 Reset Operation. At the end of each input line cycle the applicable emitter ramp capacitor (C3, C13, or C23) and

base capacitor (C4, C14, or C24) are reset to their starting voltages (-12.4V and -11V, respectively). The resetting operation is performed by the positive going rectified waveform received by the firing circuits at TP32 (Figure 4-3). Input diodes CR5, CR15, and CR25 clamp the base of the waveform at the -12.4V reference level. The reset signals are coupled to the ramp and base capacitors through diodes CR3, CR4 (phase A) CR13, CR14 (phase B) and CR23, CR24 (phase C). Reset starts during the negative transition of the reset waveform and the base and emitter capacitors require about 2msec to reach their starting voltages. The capacitors remain at this point for about 5.6msec whereupon a new ac input cycle begins and the entire operation is repeated.

**4-40 Firing Angle Determination.** The firing angle of the SCR's determines the amount of ac power applied to the input transformer and, thus, the amplitude of the dc output. An SCR that is fired at an early point in the input cycle provides a higher output than one that is fired later in the input cycle.

**4-41** Two types of inputs to the firing circuits control the time at which the firing pulses are generated. The input having the greatest degree of control is the main feedback loop input from the error amplifier. As previously mentioned, this input varies between -1V and +3V according to the output conditions. A more positive feedback voltage increases the steepness of the positive going ramp on the emitters of each blocking oscillator and the SCR's are fired early in the input cycle. The reverse is true for a more negative feedback voltage. In this manner, the feedback voltage corrects for output changes due to variations in the load resistance or line voltage.

**4-42** The second input to the firing circuits consists of the phase B and phase C control signals from the current balance circuit. These signals correct for small line-to-line variations in the three phase input currents. To accomplish this, the control signals are fed directly to base capacitors C14 and C24 in the phase B and C blocking oscillators. If the line currents are all equal to each other the two control signals are at 0V potential and do not affect the firing circuit. If the line currents become unequal, the phase B or phase C control signal swings momentarily positive or negative, depending on the polarity of the original difference. A control signal that momentarily swings negative at the base of the blocking oscillator, allows the emitter ramp voltage to catch the base voltage earlier in the cycle thus increasing the SCR firing angle. A positive going current balance control signal has the opposite effect.

**4-43 SCR Firing Circuit and Regulator Behavior at Low Outputs.** Each firing circuit and its associated SCR has a minimum operating threshold below which turn-on of either,

or both, will not occur. This threshold point varies and is determined by the inherent characteristics of both the firing circuit and the SCR of interest.

**4-44** When the supply is delivering medium and high output power, each SCR conducts once during every ac input cycle of its associated phase. However, at low power outputs, only two or even one SCR will conduct during the associated input cycle. Moreover, at very low outputs, the active SCR may skip one, or more, cycles between conduction periods. Because of these factors, the regulation, stability, overshoot, and linear programming characteristics of the supply are somewhat degraded at low outputs. The minimum outputs in both Constant Voltage and Constant Current operation at which the supply will perform within specifications are given in the output ratings of Table 1-1 in this manual.

#### **4-45 Constant Voltage Comparator**

**4-46** This circuit consists of the front panel programming resistors (R1 and R2), a differential amplifier stage, (A1U1 and associated components), and a constant current source, A1Q1. An integrated circuit is used for the differential amplifier to minimize differential voltages due to mismatched transistors and thermal differentials.

**4-47** The constant voltage comparator continuously compares the voltage drop across the VOLTAGE controls with the output voltage and, if a difference exists, produces an error voltage whose amplitude is proportional to this difference. The error signal ultimately alters the conduction angle of the SCR regulators which, in turn, alter the output current so that the output voltage becomes equal to the voltage drop across the VOLTAGE controls. Hence, through feedback action, the difference between the two inputs to U1 is held at zero volts.

**4-48** One input of the differential amplifier (pin 1) is connected to the output voltage sensing terminal of the supply (-S) through impedance equalizing resistor A1R1. The other input of the differential amplifier (pin 10) is connected to a summing point (terminal A2) at the junction of the programming resistors and resistor R6. Instantaneous changes in the output voltage or changes in the voltage at the summing point due to manipulation of the VOLTAGE controls produce a difference voltage between the two inputs of the differential amplifier. This difference voltage is amplified and appears at the output of the differential amplifier (pin 11) as an error voltage.

**4-49** Resistor R2, in series with the summing-point input to the differential amplifier, limits the current through the programming resistors during rapid voltage turn-down. Diodes CR1 and CR2 prevent excessive voltage excursions from over-driving the differential amplifier.

4-50 During constant voltage operation, the programming current flowing through the programming resistors (VOLTAGE controls) is held constant by the action of constant current source, Q1. A constant current flowing through the programming resistors assures linear constant voltage programming.

#### 4-51 Comparator Protection Circuit (used only on Models 6472C, 6475C, 6477C, 6479C, and 6483C)

4-52 As indicated in the above paragraph heading, this circuit is only used in the higher voltage Models of the SCR-10 Series of power supplies. The circuit consists of a small three phase power supply which is used to forward bias diode A1CR3. The power supply consists of wye connected transformers A3T1, A3T2, and A3T3, and a half-wave rectifier (A1CR5, CR6, CR7) and filter (A1C4). During normal operation, this supply forward biases protection diode CR3, which is connected in series with the summing input to A1U1 (pin 10). Under these conditions, the diode acts as a near short circuit and has no effect on the operation of the constant voltage comparator. However, under no-load conditions (or with a highly capacitive load), if the supply is rapidly down programmed, diode CR3 becomes reverse biased due to a positive going transient at its cathode. With diode CR3 reverse biased, the input path to comparator A1U1 is opened preventing damage to the device.

#### 4-53 Constant Current Comparator

4-54 This circuit is similar in appearance and operation to the constant voltage comparator circuit. It consists of the coarse and fine current controls (R3 and R4) and a differential amplifier stage (U2 and associated components). As in the constant voltage comparator, an integrated circuit is used for the differential amplifier to minimize differential voltages due to mismatched transistors and thermal differentials.

4-55 The constant current comparator circuit continuously compares the voltage drop across the CURRENT controls with the voltage drop across the current sampling resistors A4R123A - A4R123B. If a difference exists, the differential amplifier produces an error signal which is proportional to this difference. The remaining components in the feedback loop (amplifiers, firing circuit and SCR's) function to maintain the drop across the current sampling resistors, and hence the output current, at a constant value.

4-56 One input of the differential amplifier (pin 1) is connected to the supply's common point  which is tied to the outbound side of the sampling resistors. The other input of the differential amplifier (pin 10) is connected to a summing point (terminal A6) at the junction of the programming resistors and the current pullout resistors R25 and R26.

Changes in the output current due to load changes or changes in the voltage at the summing point due to manipulation of the CURRENT controls produce a difference voltage between the two inputs of the differential amplifier. This difference voltage is amplified and appears at the output of the differential amplifier (pin 12) as an error voltage which ultimately varies the conduction of the SCR's.

#### 4-57 Error Amplifier

4-58 Operational amplifier stage U3 provides most of the feedback loop gain. During normal operation, U3 receives the feedback voltage at its non-inverting input from either the constant voltage or constant current comparator via OR-gate diode CR23 or CR24. Diode CR23 is forward biased and CR24 reverse biased during constant voltage operation. The reverse is true during constant current operation.

4-59 Under overcurrent conditions, U3 can also be driven by the overcurrent protection circuit via OR-gate diode CR25. As previously mentioned, protection circuit inputs are applied directly to pin 3 of U3.

4-60 Feedback networks C15, R50 and C20, R46 shape the high frequency rolloff in the loop gain response to stabilize the feedback loop.

#### 4-61 Overcurrent Protection Circuit

4-62 Stage U2 monitors the output current (IR drop across the sampling resistors) and conducts if the output current exceeds about 115% of the output current rating. Resistor A1R38 is factory selected to set the 115% threshold point.

#### 4-63 Turn-On Control

4-64 This circuit minimizes turn-on overshoot by keeping the SCR's off for approximately 20 seconds after the unit is turned on. At turn-on, Q4 conducts, providing a less positive voltage to the error amplifier. This voltage keeps the SCR's off until C23 charges up turning off Q4. Diode CR27 provides a quick discharge path for C23 when the supply is turned off.

#### 4-65 Overvoltage Protection Circuit

4-66 This circuit prevents the output voltage from exceeding approximately 110% of the maximum voltage rating. Under non-overvoltage conditions, transistor Q10 is cutoff due to the -12.4V bias connected to its base. If the voltage at the + output bus becomes positive enough (exceeds the 110% threshold) Q10 conducts clamping the error amplifier input. Resistor R82, mounted on standoffs, is factory selected to obtain the desired trip point.

## 4-67 Phase Protection Circuit

4-68 This circuit protects the SCR's and power transformer in case one of the input phases should fail. The three phase input ac is rectified by CR38, CR39 and CR40, filtered by C30, and the resultant voltage on the base of Q9 is normally negative enough to hold the transistor off. However, if one of the input phases fails, (or if all three phases drop below 25% of the nominal voltage) the voltage across C30 becomes positive enough to break down zener diode VR10 and drive Q9 into conduction. The conduction of Q9 clamps the input to the error amplifier to a less positive voltage, thus turning off the SCR's.

4-69 Resistor R77, in the base circuit of Q9, is factory selected to obtain the desired trip point.

## 4-70 Early Overcurrent Protection

4-71 This circuit provides rapid protection for the load during initial short circuit conditions. When activated, this circuit injects a negative cutoff voltage directly into the firing circuits by passing the loop delay caused by the error amplifier.

4-72 A voltage that is proportional to the line current is applied to stage A1Q3 from a rectifier and filter (shared by the overload circuit). Without an overload, transistor Q3 is conducting but not sufficiently to breakdown VR4 in its collector circuit. Thus, A1Q2 is cutoff and the circuit is deactivated. The circuit becomes activated if the input line current rises to about 40% of its normal peak value. In this case, the increased conduction of Q3 breaks down zener diode VR4, forward biasing CR19 and CR22 and permitting Q2 to conduct. The negative output voltage is applied to the firing circuits halting SCR conduction until the output current falls to an acceptable level.

## 4-73 Current Balance Circuit

4-74 This circuit controls the firing of the phase B and phase C SCR's so that the input currents on these lines are equal in amplitude to the input current on the phase A (reference) line.

4-75 The current balancing circuit for each of the corrected phases (B and C) receives its input directly from the associated input wire, which is run physically through the air-core of input transformer A3T10 and A3T11, respectively. Each input wire serves as the primary of its input transformer, inducing the ac current flowing along that wire into the secondary winding. The ac current waveform on each input wire is of a rectangular shape and consists of positive and negative excursions. The negative current flows through the SCR associated with the input line while the positive current

flows through a companion diode (CR1, CR2, or CR3) and is, in fact, the return current from another phase. The return current for the reference phase (A) flows through diode CR2 or CR3 and, therefore, appears on the phase B or C line as a positive going pulse. The return current for phase B appears on the input lines of phase A or C, and the return current for phase C appears on the input line of phase A or phase B.

4-76 It is the function of each current balancing circuit to maintain the amplitudes of these positive and negative input currents equal. The positive pulses are rectified by CR46/CR48, filtered by C34/C44, and the resultant positive dc current is applied to the pin 2 of U4/U5 via summing resistor R95/R115. The negative excursions are rectified by CR45/CR47, filtered by C35/C45, and the negative dc current is summed with the positive current by summing network R94, R95/R114, R115. If the amplitude of the positive and negative currents are unequal, an error signal is developed at the output of U4/U5 and fed to the firing circuits. This error signal affects the bias on the base of Q2/Q3 and ultimately advances or delays the firing of the SCR's according to the polarity of the original error signal. Once the amplitudes of each of the positive and negative input currents become equal, no error signal (zero volts) is generated by U4/U5.

4-77 Potentiometers R101 and R121 provide a means of offsetting minor differences in the phase B and phase C current balance loop.

## 4-78 Overload Circuit

4-79 The overload circuit detects the presence of an over-temperature or extended overcurrent condition and deenergizes power contactor K2 if either of these conditions occur. The circuit also provides a visual indication of both conditions.

4-80 Overcurrent Circuit. Diodes CR50 through CR53 and capacitor C52 rectify and filter the phase B and C line voltage to provide a dc voltage which is equivalent to the line current. During normal conditions, (no overload) the rectified voltage is not sufficiently positive to turn-on unijunction transistor Q11. With Q11 off, relay K1 is energized once power is applied to bridge rectifier CR54-CR57 through the LINE switch. Closed contacts (8 and 12) of K1 then allow K2 to energize, permitting application of the main three phase power to the unit.

4-81 If the rms amplitude of the line current rises above 40% of the input line rating, Q11 turns on providing a positive pulse to transformer T6. This pulse fires an SCR (CR58) connected across relay K1. With K1 deenergized, the ac path to contactor K2 is broken deenergizing this relay



and removing the ac power. Notice that 2 phase power is still applied to the overload circuit keeping CR58 in conduction and illuminating the OVERCURRENT PROTECT lamp through closed contacts of K1. It requires approximately one second for the relays to deenergize and shut off power.

4-82 Overload relay K1 is also deenergized if the crowbar circuit (optional circuit) is activated. The pulse is applied to an additional winding of T6 to SCR CR58. The OVERCURRENT PROTECT lamp will also be illuminated in this case together with the CROWBAR lamp.

4-83 After an overload occurs and the condition has been corrected, the operator must set the LINE switch to OFF, wait at least 3 seconds, and then set the LINE switch to ON.

4-84 Overtemperature Circuit. The overtemperature components are TC1 and parallel connected TEMPERATURE lamp DS3. Thermal switch TC1 is closed without an overtemperature condition. The near short circuit, created by TC1 across TEMPERATURE lamp DS3 keeps the lamp off during this condition. If the heat sink temperature rises above the limits specified in Paragraph 4-25, TC1 opens

deenergizing contactor K2 and allowing the TEMPERATURE lamp to light. When the unit cools sufficiently, TC1 again closes.

#### 4-85 Reference Supply

4-86 The reference supply is a self-contained feedback supply employing a series regulator. The supply provides stable reference voltages which are used throughout the unit.

4-87 The reference voltages are all derived from a full wave rectifier (CR28 through CR33) and filter (C25) which provide an unregulated -24Vdc. The regulating circuit consists of series regulator Q5, driver Q6, and differential amplifier stage Q7 and Q8. The differential amplifier compares the voltage at the junction of a voltage divider (equal resistors R64 and R69) connected across the output (24.8V) with the voltage at the supply's common point,  $\nabla$ . Any difference in voltage is detected and fed to series regulator Q5 in the correct phase and amplitude to maintain the output constant. The +6.3 and -8.2 voltages are developed across zener diodes VR1 and VR5. Output capacitors C27 and C28 stabilize the regulator feedback loop.

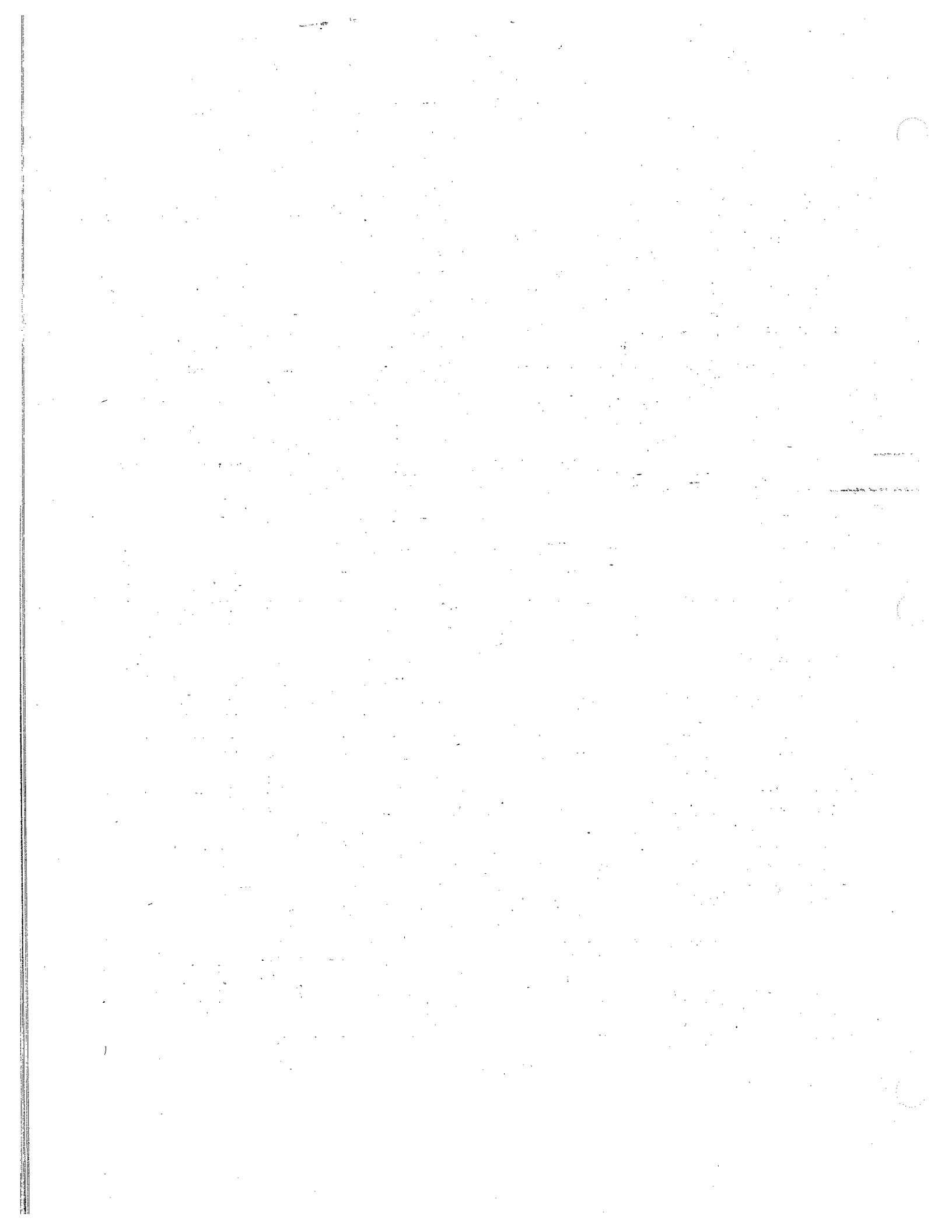

## SECTION V MAINTENANCE

### 5-1 INTRODUCTION

5-2 Upon receipt of the power supply, the performance check (Paragraph 5-5) should be made. This check is suitable for incoming inspection. If a fault is detected in the power supply while making the performance check or during normal operation, proceed to the troubleshooting procedures (Paragraph 5-35). After troubleshooting and repair (Paragraph 5-54), perform any necessary adjustments and calibrations (Paragraph 5-68). Before returning the power supply

to normal operation, repeat the performance check to ensure that the fault has been properly corrected and that no other faults exist. Before performing any maintenance checks, turn on the power supply and allow a half-hour warm-up.

### 5-3 TEST EQUIPMENT REQUIRED

5-4 Table 5-1 lists the test equipment required to perform the various procedures described in this section.

Table 5-1. Test Equipment Required

TYPE	REQUIRED CHARACTERISTICS	USE	RECOMMENDED MODEL
Differential Voltmeter	Sensitivity: 1mV full scale (min.) Input impedance: 1.0M $\Omega$ (min.).	Measure dc voltages; calibration procedures.	HP 3420A/B
Oscilloscope	Sensitivity and bandwidth: 100 $\mu$ V/cm and 400kHz for all measurements except noise spike; 5mV sensitivity and 20MHz bandwidth for noise spike measurement.	Measure ripple; display transient recovery waveform; measure noise spikes.	HP 140A with 1423A time base and 1400A vertical plug-in; 1402A plug-in for spike measurement.
Variable Voltage Transformer	18kVA open Delta 0-270Vac or 54.3kVA 0-560V 56A.	Vary ac input for line regulation measurement.	General Radio Model W30HG-2 or Power Stat Type 1256D-64.
AC Voltmeter	Sensitivity: 1mV full scale deflection (min.) Accuracy: 2%.	Measure ac voltages and ripple.	HP 403B.
DC Voltmeter	Sensitivity: 1mV full scale deflection (min.) Accuracy: 1%.	Measure dc voltages.	HP 412A.
AC Ammeter	0-300A clip-on probe.	Measure ac line current.	Amprobe Model RS-3.
Resistive Loads	Value: see Figure 5-1. 10kW rating.	Power supply load resistors.	
Current Sampling Resistors (Shunts)	Accuracy: 1%. Provides 50mV at rated output current. Values: see Figure 5-7.	Measure output current; calibrate ammeter.	Simpson Switchboard Type Shunts. 6500 or 6700 Series.

## 5-5 PERFORMANCE TEST

5-6 The following test can be used as an incoming inspection check and appropriate portions of the test can be repeated either to check the operation of the instrument after repairs or for periodic maintenance tests. The tests are performed using the rated 3 phase input power source. If the correct result is not obtained for a particular check, do not adjust any internal controls; proceed to troubleshooting (Paragraph 5-35).

## 5-7 Constant Voltage Tests

5-8 If maximum accuracy is to be obtained in the following measurements, the measuring devices must be connected to the sensing terminals (+S, -S). This is particularly important when measuring the transient response, regulation, or ripple of the power supply. A measurement made across the load includes the impedance of the leads to the load and such lead lengths can easily have an impedance several orders of magnitude greater than the supply impedance, thus invalidating the measurement.

5-9 To avoid mutual coupling effects, each monitoring device must be connected to the sensing terminals by a separate pair of leads. Twisted pairs or shielded two-wire cables should be used to avoid pickup on the measuring leads. The load resistor should be connected across the output busbars as close to the supply as possible. When measuring the constant voltage performance specifications, the current controls should be set well above (at least 10%) the maximum output current which the supply will draw, since the onset of constant current action will cause a drop in output voltage, increased ripple, and other performance changes not properly ascribed to the constant voltage operation of the supply.

### CAUTION

*Never connect a load (or a short) to the + and - output or sensing terminals located on the rear terminal strips. This causes the heavy load current to flow through the P.C. Board tracks and consequent damage to the P.C. Board. Loads must always be connected to the busbars.*

### WARNING

*Exercise caution when checking out any 10kW unit since high potentials are provided by the unit. Rubber gloves are recommended to protect against shock hazard.*

5-10 Voltage Output and Voltmeter Accuracy. To check the output voltage, proceed as follows:

- Connect load resistor ( $R_L$ ) indicated in Figure 5-2 across output busbars.
- Connect differential voltmeter across +S and -S terminals of supply, observing correct polarity.
- Turn CURRENT controls fully clockwise.
- Turn on supply and adjust VOLTAGE controls until front panel meter indicates exactly maximum rated output voltage.
- Differential voltmeter should indicate maximum rated output voltage  $\pm 2\%$ .

## 5-11 Load Regulation.

Definition: The change  $\Delta E_{OUT}$  in the static value of dc output voltage resulting from a change in load resistance from open circuit to a value which yields maximum rated output current (or vice versa).

5-12 To check the constant voltage load regulation, proceed as follows:

- Connect test setup shown in Figure 5-1.
- Turn CURRENT controls fully clockwise.
- Turn on supply and adjust VOLTAGE controls until front panel meter indicates exactly maximum rated output voltage.
- Read and record voltage indicated on differential voltmeter.
- Disconnect load resistor.
- Reading on differential voltmeter should not vary.

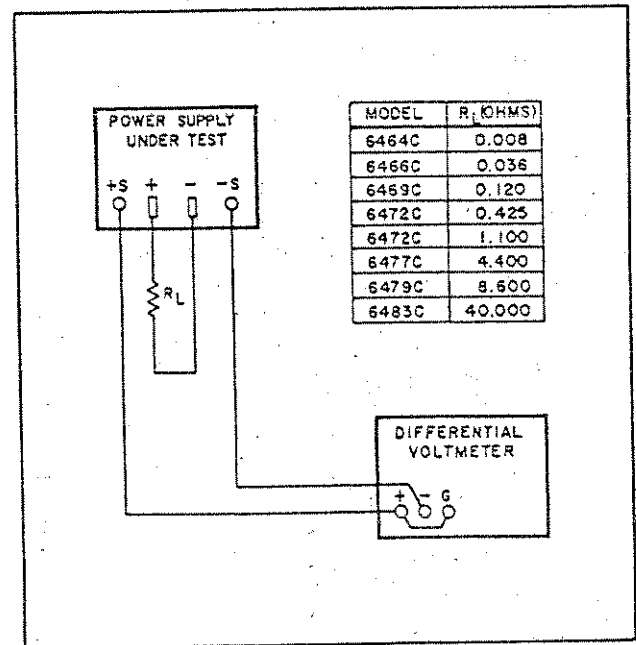

Figure 5-1. Constant Voltage Load Regulation Test Setup

from reading recorded in Step (d) by more than:

Model	Variation (mVdc)
6464C	9
6466C	14
6469C	23
6472C	132
6475C	155
6477C	200
6479C	250
6483C	400

### 5-13 Line Regulation.

Definition: The change  $\Delta E_{OUT}$  in the static value of dc output voltage resulting from a change in ac input voltage over the specified range from low line to high line, or from high line to low line.

5-14 To check the line regulation, proceed as follows:

- Connect test setup shown in Figure 5-1.
- Connect variable auto transformer between input power source and power supply power input.
- Adjust variable auto transformer for low line input (-10% of input rating).
- Turn CURRENT controls fully clockwise.
- Turn on supply and adjust VOLTAGE controls until front panel meter indicates exactly maximum rated output voltage.
- Read and record voltage indicated on differential voltmeter.
- Adjust variable auto transformer for high line input (+10% of input rating).
- Reading on differential voltmeter should not vary from reading recorded in Step (f) by more than:

Model	Variation (mVdc)
6464C	9
6466C	14
6469C	23
6472C	132
6475C	155
6477C	200
6479C	250
6483C	400

### 5-15 Ripple and Noise.

Definition: The residual ac voltage superimposed on the dc output of a regulated power supply. Ripple and noise may be specified and measured in terms of its rms or (preferably) peak-to-peak value.

Ripple and noise measurement can be made at any input ac line voltage combined with any dc output voltage and load current within the supply's rating.

5-16 The amount of ripple and noise that is present in the power supply output is measured either in terms of the rms

or (preferably) peak-to-peak value. The peak-to-peak measurement is particularly important for applications where noise spikes could be detrimental to a sensitive load. The rms measurement is not an ideal representation of the noise, since fairly high output noise spikes of short duration can be present in the ripple without appreciably increasing the rms value.

5-17 Figure 5-2 shows the recommended method of measuring ripple using a differential scope. If desired, two single-conductor shielded cables may be substituted in place of the shielded two-wire cable with equal success. Because of its common mode rejection, a differential oscilloscope displays only the difference in signal between its two vertical input terminals, thus ignoring the effects of any common mode signal produced by the difference in the ac potential between the power supply case and scope case. Before using a differential input scope in this manner, however, it is imperative that the common mode rejection capability of the scope be verified by shorting together its two input leads at the power supply and observing the trace on the CRT. If this trace is a straight line, then the scope is properly ignoring any common mode signal present. If this trace is not a straight line, then the scope is not rejecting the ground signal and must be realigned in accordance with the manufacturer's instructions until proper common mode rejection is attained.

5-18 Although for this measurement the negative busbar is connected to chassis ground, the user should bear in mind that neither busbar should be connected to chassis in an actual operational setup (refer to Paragraph 3-19).

5-19 To check the ripple output, proceed as follows:

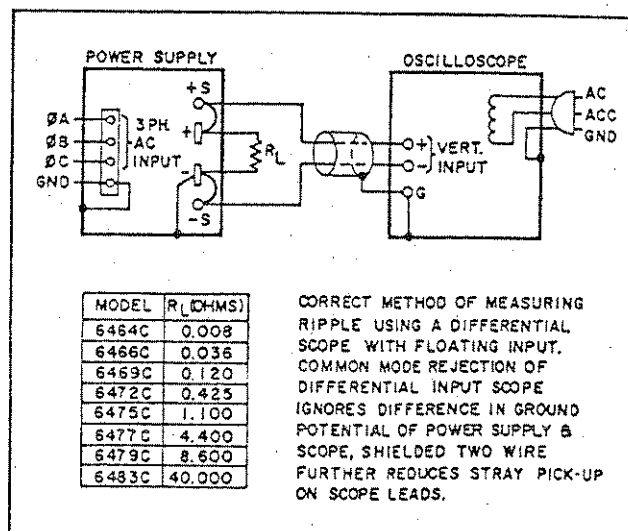

Figure 5-2. Ripple Test Setup

- a. Connect oscilloscope or rms voltmeter as shown in Figure 5-2.
- b. Turn CURRENT controls fully clockwise.
- c. Adjust VOLTAGE controls until front panel meter indicates maximum rated output voltage.
- d. The observed ripple should be less than the following:

Model	Rms/Peak-to-Peak
6464C	80mV/1V
6466C	180mV/1V
6469C	180mV/1V
6472C	160mV/2V
6475C	220mV/2V
6477C	330mV/2V
6479C	300mV/2V
6483C	600mV/5V

**5-20 Noise Spike Measurement.** When a high frequency spike measurement is being made, an instrument of sufficient bandwidth must be used; an oscilloscope with a bandwidth of 20MHz or more is adequate. Measuring noise with an instrument that has insufficient bandwidth may conceal high frequency spikes detrimental to the load.

**5-21** The test setup illustrated in Figure 5-2 is generally not acceptable for measuring spikes:

1. As shown in Figure 5-3, two coax cables must be substituted for the shielded two-wire cable.
2. Impedance matching resistors must be included to eliminate standing waves and cable ringing, and capacitors must be inserted to block the dc current path.
3. The length of the test leads outside the coax is critical and must be kept as short as possible; the blocking capacitor and the impedance matching resistor should be connected directly from the inner conductor of the cable to the power supply terminals.
4. Notice that the shields of the power supply end of the two coax cables are not connected to the power supply

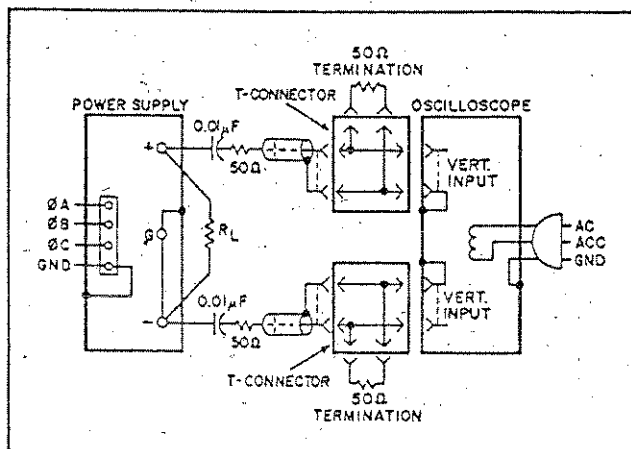

Figure 5-3. Noise Spike Measurement Test Setup

ground, since such a connection would give rise to a ground current path through the coax shield, resulting in an erroneous measurement.

5. Since the impedance matching resistors constitute a 2-to-1 attenuator, the noise spikes observed on the oscilloscope should be less than half the peak-to-peak values given in Paragraph 5-19, Step (d).

**5-22** The circuit of Figure 5-3 can also be used for the normal measurement of low frequency ripple; simply remove the four terminating resistors and the blocking capacitors and substitute a higher gain vertical plug-in in place of the wide-band plug-in required for spike measurements. Notice that with these changes, Figure 5-3 becomes a two-cable version of Figure 5-2.

### 5-23 Transient Recovery Time.

**Definition:** The time required for output voltage recovery to within the given level of the nominal output voltage following a load change from full load to half load or half load to full load.

**5-24** Transient recovery time may be measured at any input line voltage combined with any output voltage and load current within rating.

**5-25** A hand-operated switch is used to switch from full load to half load and the resultant one-shot displays are observed on an oscilloscope.

**5-26** To check the transient recovery time, proceed as follows:

- a. Connect test setup shown in Figure 5-4.

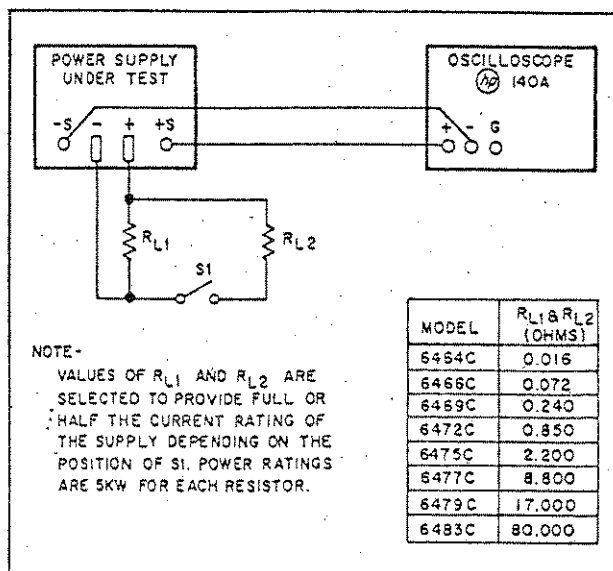

Figure 5-4. Transient Recovery Time Test Setup

- b. Turn CURRENT controls fully clockwise.
- c. Turn on supply and adjust VOLTAGE controls until front panel ammeter indicates half the rated output current.
- d. Close and open switch S1 several times and observe oscilloscope display.
- e. Starting from the major graticule division representative of time zero, count to the right either 50 milliseconds or 100 milliseconds and vertically "y" millivolts. Recovery should be within the tolerances of "y1" or "y2" as shown in Figure 5-5.

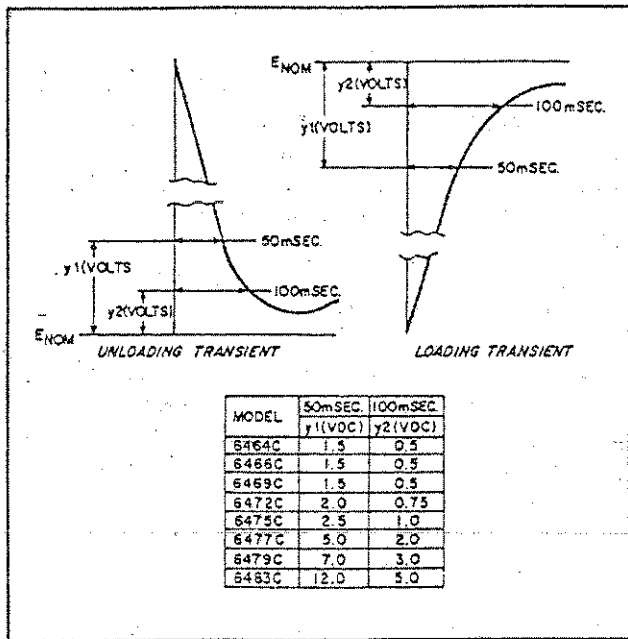

Figure 5-5. Transient Recovery Time Waveforms

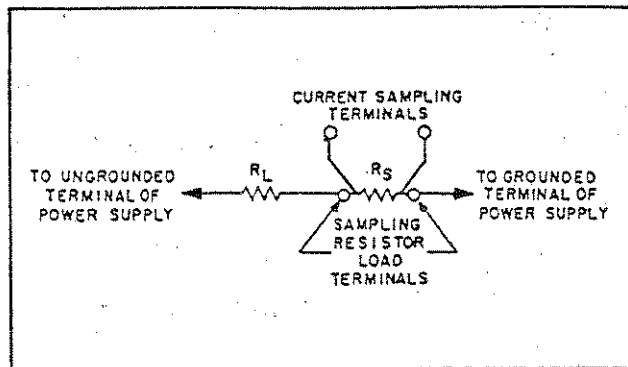

Figure 5-6. Current Sampling Resistor Connections

### 5-27 Constant Current Tests

5-28 The instruments, methods, and precautions for the proper measurement of constant current power supply

characteristics are for the most part identical to those already described for the measurement of constant voltage power supplies. There are, however, two main differences: first, the power supply performance will be checked between *short* circuit and full load rather than *open* circuit and full load. Second, a current monitoring resistor is inserted between the output of the power supply and the load.

5-29 For all output current measurements the current sampling resistor is a four terminal meter shunt. The load current is fed to the extremes of the wire leading to the shunt resistance while the sampling terminals are located as close as possible to the resistance portion itself (see Figure 5-6). Recommended sampling shunts are given in Table 5-1.

### 5-30 Rated Output and Meter Accuracy.

- a. Connect test setup shown in Figure 5-7.
- b. Turn VOLTAGE controls fully clockwise.
- c. Turn on supply and adjust CURRENT controls until front panel ammeter indicates maximum rated output current.
- d. Differential voltmeter should read voltage corresponding to rated output current  $\pm 3\%$ .

### 5-31 Load Regulation.

Definition: The change  $\Delta I_{OUT}$  in the static value of the dc output current resulting from a change in load resistance from short circuit to a value which yields maximum rated output voltage.

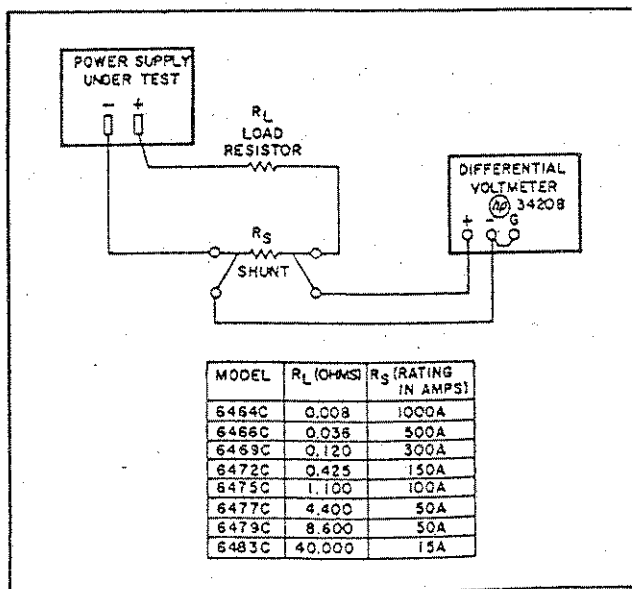

Figure 5-7. Constant Current Test Setup

5-32 To check the constant current load regulation, proceed as follows:

- a. Connect test setup shown in Figure 5-7.
- b. Turn VOLTAGE controls fully clockwise.
- c. Adjust CURRENT controls until front panel meter reads exactly maximum rated output current (500A and 15A for Models 6466C and 6483C, respectively).
- d. Read and record voltage indicated on differential voltmeter.
- e. Short circuit load resistor ( $R_L$ ).
- f. Reading on differential voltmeter should not vary from reading recorded in Step (d) by more than the following:

Model	Variation ( $\mu$ Vdc)
6464C	100
6466C	110
6469C	100
6472C	100
6475C	100
6477C	100
6479C	70
6483C	166

### 5-33 Line Regulation.

Definition: The change  $\Delta I_{OUT}$  in the static value of dc output current resulting from a change in ac input voltage over the specified range from low line to high line, or from high line to low line.

5-34 To check the line regulation, proceed as follows:

- a. Utilize test setup shown in Figure 5-7.
- b. Connect variable auto transformer between input power source and power supply power input.
- c. Adjust auto transformer for low line input (-10% of line rating).
- d. Turn VOLTAGE controls fully clockwise.
- e. Adjust CURRENT controls until front panel ammeter reads exactly maximum rated output current (lowest current range for Models 6466C and 6483C).
- f. Read and record voltage indicated on differential voltmeter.
- g. Adjust variable auto transformer for high line input (+10% of line rating).
- h. Reading on differential voltmeter should not vary from reading recorded in Step (f) by more than:

Model	Variation ( $\mu$ Vdc)
6464C	100
6466C	110
6469C	100
6472C	100
6475C	100
6477C	100
6479C	70
6483C	166

## 5-35 TROUBLESHOOTING

5-36 Before attempting to troubleshoot this instrument, ensure that the fault is with the instrument and not with an associated circuit. The performance test (Paragraph 5-5) enables this to be determined without having to remove the instrument from the cabinet.

5-37 A good understanding of the principles of operation is a helpful aid in troubleshooting, and it is recommended that the reader review Section IV of the manual before attempting to troubleshoot the unit in detail. Once the principles of operation are understood, refer to the overall troubleshooting procedures in Paragraph 5-40 to locate the symptom and probable cause.

5-38 The schematic diagram at the rear of the manual contains normal voltage readings taken at various points within the circuits. These voltages are positioned adjacent to the applicable test points (identified by encircled numbers). The component location diagrams (Figures 7-1 through 7-5) at the rear of the manual should be consulted to determine the location of components and test points.

5-39 If a defective component is located, replace it and re-conduct the performance test. When a component is replaced, refer to the repair and replacements (Paragraph 5-54) and adjustment and calibration (Paragraph 5-68) sections of this manual.

### 5-40 Overall Troubleshooting Procedure

5-41 To locate the cause of trouble, follow steps 1, 2, and 3 in sequence:

(1) Check for obvious troubles such as input power failure, loose or incorrect strapping on rear terminals, blown fuses or defective meter.

(2) In almost all cases, the trouble can be caused by the dc bias or reference voltages; thus, it is a good practice to check voltages in Table 5-2 before proceeding with Step (3).

(3) Disconnect load and proceed to the next Paragraph, 5-42.

5-42 General. Any trouble with the supply can be isolated by following the overall troubleshooting procedures outlined in the subsequent paragraphs. However, if the unit fails one of the performance tests, or the unit is unstable, but otherwise appears to operate normally, it is more expedient for the technician to refer to the miscellaneous troubles shown in Table 5-3. For all other troubles, proceed as directed in the following paragraphs.

5-43 Initial Setup. Proceed as follows before attempting to troubleshoot the instrument:



1. Troubleshooting is more effective if the unit is operated in the normal mode (local sensing, local programming). Strap the rear terminals as shown in Figure 3-2.

2. With the supply off, disconnect all loads from the unit.

3. Before turning on the supply, set the front panel CURRENT controls maximum ccw and the VOLTAGE controls to mid-range. Proceed to overall troubleshooting tree, Figure 5-8.

Table 5-2. Reference and Bias Voltages  
(Refer to Schematic for Test Point Locations)





STEP	METER COMMON	METER POSITIVE	NORMAL VDC	NORMAL RIPPLE (P-P)	PROBABLE CAUSE
1	4		$12.4 \pm 0.7$	10mV	A1Q5 through A1Q8, A1VR6, A1VR7.
2	3		$8.2 \pm 0.42$	10mV	A1VR1.
3		2	$6.2 \pm 0.32$	2mV	A1VR5.
4		17	$6.2 \pm 0.32$	10mV	A1VR3.
5	A0	-S	$6.8 \pm 0.4$	10mV	A1Q1 or A1VR2.
6		1	$12.4 \pm 0.7$	50mV	A1VR5.

Table 5-3. Miscellaneous Troubles

SYMPTOM	PROBABLE CAUSE
High Ripple	<ul style="list-style-type: none"> <li>a. Check operating setup for ground loops.</li> <li>b. Check reference voltages (Table 5-2) for excessive ripple.</li> <li>c. Supply crossing over to constant current operation under loaded conditions. Check current limit setting or constant current comparator circuit (Paragraph 5-47).</li> </ul>
Poor Line Regulation	<ul style="list-style-type: none"> <li>a. Improper measurement technique (Paragraph 5-13).</li> <li>b. Check reference voltages (Table 5-2).</li> </ul>
Poor Load Regulation (Constant Voltage)	<ul style="list-style-type: none"> <li>a. Measurement technique (Paragraph 5-11).</li> <li>b. Reference circuit (Table 5-2).</li> <li>c. Ensure that supply is not current limiting. Check constant current comparator circuit (Paragraph 5-47).</li> </ul>
Poor Load Regulation (Constant Current)	<ul style="list-style-type: none"> <li>a. Reference circuit (Table 5-2).</li> <li>b. Improper measurement technique.</li> <li>c. Ensure that supply is not voltage limiting. Check constant voltage comparator circuit (Paragraph 5-46).</li> </ul>
Oscillates (Constant Voltage/Constant Current)	<ul style="list-style-type: none"> <li>a. Adjustment of R36 (Paragraph 5-78).</li> <li>b. Open sensing lead (+S).</li> </ul>

Table 5-3. Miscellaneous Troubles (Continued)

SYMPTOM	PROBABLE CAUSE
Instability (Constant Voltage/Constant Current)	a. Reference circuit (Table 5-2). b. Noisy voltage or current controls (R1,R2 or R3,R4). c. Stage A1U1 or A1U2 defective. d. CR1, CR2, or CR8 leaky. e. A1CR1, CR2, CR13, CR14, C1, C6, C10, VR2 noisy or drifting.

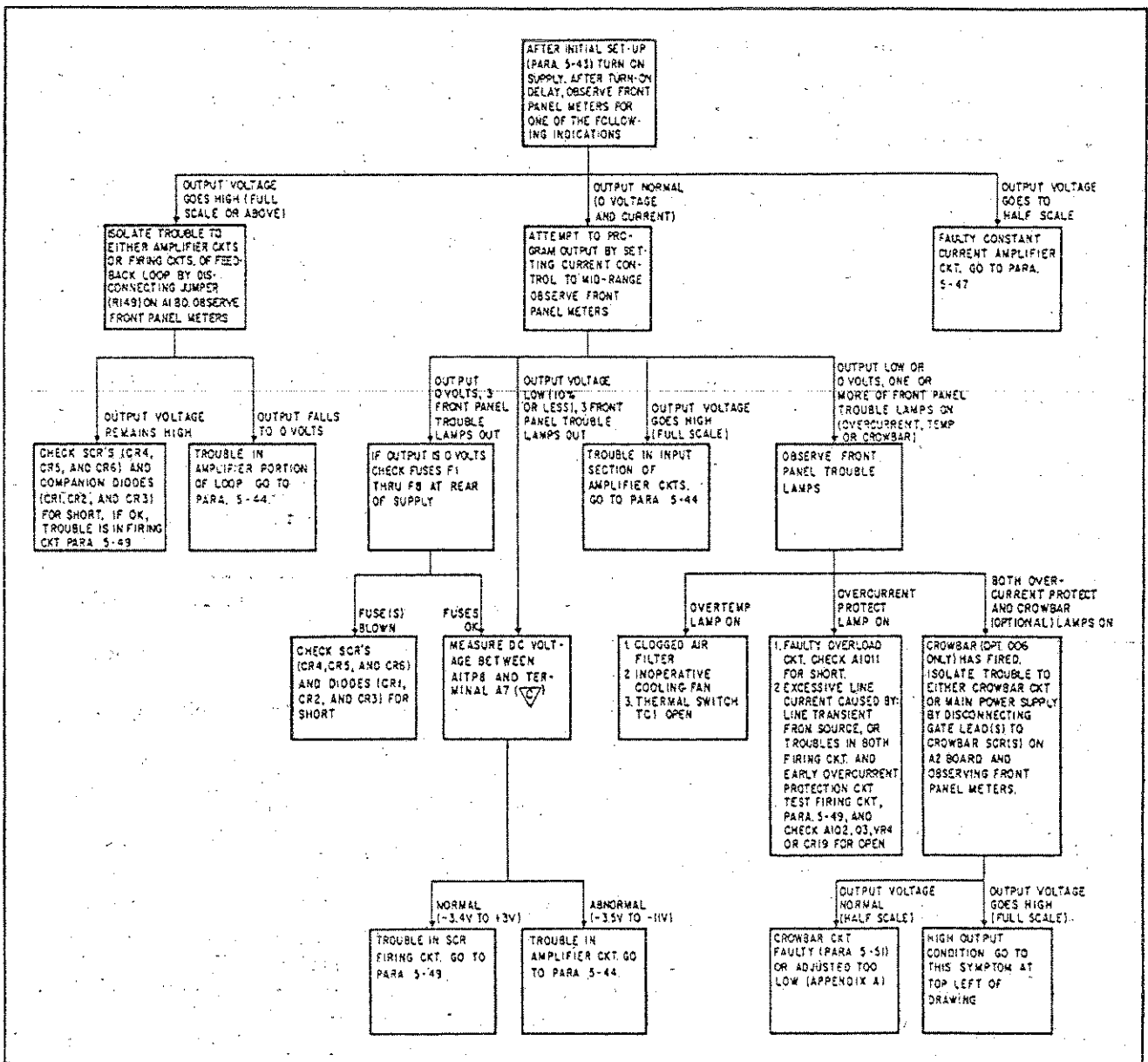

Figure 5-8. Overall Troubleshooting Tree

## 5-44 Amplifier Circuits, Open Loop Troubleshooting

5-45 The following paragraphs test the amplifier portion of the feedback loop. Except for the front panel controls, all of the circuitry involved is located on the amplifier P.C. Board, A1. The overall test is divided into three separate sub-tests; constant voltage comparator, constant current comparator, and error amplifier. All tests are performed with the feedback loop opened (jumper R149 removed, see Figure 7-1 for location) and no load connected to the supply.

5-46 Constant Voltage Comparator. To test the CV comparator circuit (A1U1 and associated components) proceed as follows:

- Strap the rear terminals for normal operation (Figure 3-2) except remove jumper straps between + - +S and A7 - A8.
- Connect external battery and resistors as shown in Figure 5-9. A "D"-size flashlight cell is adequate for this test.
- Before turning on supply, connect dc voltmeter across output of A1U1 between TP9 and terminal A7. Ensure that jumper A1R149 is removed.
- Next, turn CURRENT controls fully clockwise (cw) and VOLTAGE controls fully counterclockwise (ccw).
- Turn-on power supply and, after 10 to 20 seconds turn on delay, observe voltmeter reading.
- Voltmeter should read  $+0.8 \pm 0.08\text{Vdc}$  with VOLTAGE controls fully ccw. If it does, proceed to next step. If it does not, check A1U1 and associated components (including VOLTAGE controls R1 and R2 on front panel).

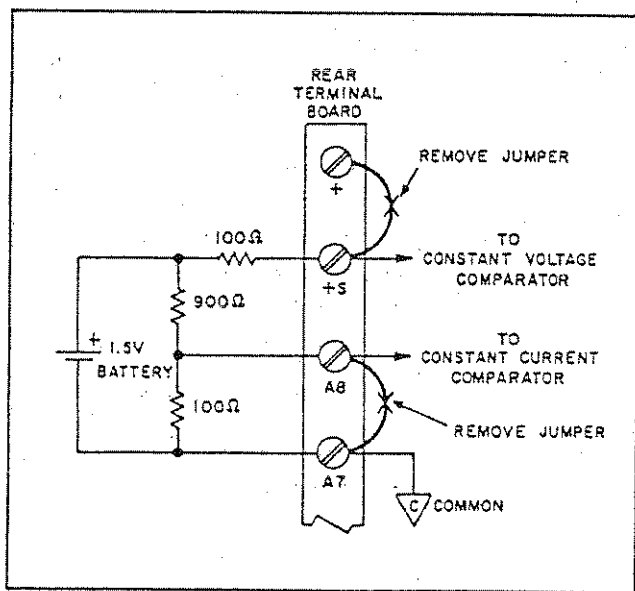

Figure 5-9. Open Loop Test Setup, Amplifier Circuit

g. Rotate VOLTAGE controls fully cw and again observe voltmeter.

h. Voltmeter should read  $+11 \pm 1.1\text{Vdc}$  with VOLTAGE controls fully cw. If it does, proceed to next portion of test. If it does not, check A1U1 and associated components (including the front panel VOLTAGE controls).

5-47 Constant Current Comparator. To test the constant current comparator circuit (A1U2 and associated components) proceed as follows:

- Connect test setup of Figure 5-9.
- Connect dc voltmeter across output of constant current comparator section of A1U2, between TP10 and terminal A7.
- Turn VOLTAGE and CURRENT controls fully cw. Ensure that circuit is open loop (jumper A1R149 removed).
- Turn on supply (no load connected) and observe voltmeter reading after turn on delay period.
- Voltmeter should read  $+7.8 \pm 0.78\text{Vdc}$  with CURRENT controls fully cw. If it does, proceed to next step. If it does not, check A1U2 and associated components, including front panel CURRENT controls.
- Rotate CURRENT controls fully ccw and observe voltmeter reading.
- Voltmeter should read  $+3.1 \pm 0.31\text{Vdc}$  with CURRENT controls fully ccw. If it does, proceed to next portion of test. If it does not, check A1U2 and associated components.

5-48 Error Amplifier. This test checks the error amplifier (A1U3) and all of the protection circuits connected to its input. First, the output of the amplifier is checked. If this is unsatisfactory, the input to the amplifier is measured to determine if one of the protection circuits is the cause of the malfunction. To perform this test proceed as follows:

- Use test setup of Figure 5-9. Ensure that circuit is open loop (jumper A1R149 removed).
- Connect dc voltmeter across output of A1U3, between TP8 and terminal A7.
- Rotate VOLTAGE and CURRENT controls fully cw.
- Turn on supply and observe voltmeter reading after turn on delay.
- Voltmeter should read  $+11 \pm 1.1\text{Vdc}$ . If it does, proceed to next step (f). If it does not, check input voltage as directed in Step (g).
- Rotate VOLTAGE controls fully ccw and observe voltmeter. Reading should be  $-11 \pm 1.1\text{Vdc}$ . If it is, error amplifier and front end circuits are operating correctly. If reading is not  $-11 \pm 1.1\text{Vdc}$ , proceed to next step, (g).
- Measure voltage at input of A1U3, between TP19 and terminal A7. Next, measure voltage between TP17 and terminal A7 (other input to A1U3).
- Both measurements (TP17 and TP19) should be  $+6 \pm 1\text{Vdc}$ . If these input readings are correct, but either output

reading (Step e or Step F) was incorrect, check A1U3. Also, A1Q2 and A1Q3 can shunt down the output of the error amplifier if either is shorted.

i. If either input measurement is not  $+6 \pm 1\text{Vdc}$ , check for a shorted transistor (A1Q4, Q9, or Q10) in the protection circuits. Also, check zener diode A1VR3. Finally, check voltage at output of backup overcurrent protection circuit (TP11 and terminal A7). It should be  $+12 \pm 2\text{Vdc}$  with any front panel setting of the CURRENT control. If reading is not within tolerances, check A1U2 and associated components.

#### 5-49 Firing Circuits, Open Loop Troubleshooting

5-50 All of the firing circuitry that controls the SCR's is located on the firing board, A2. The test is performed open loop (jumper strap R149 removed) with a  $10\text{k}\Omega$ , 10-turn potentiometer connected to TP18 as shown on the schematic and described on NOTE 14. The check is made by observing circuit waveforms shown at the rear of the manual. As indicated in Table 5-4, all three firing circuits are checked starting with phase A.

Table 5-4. Firing Circuit Troubleshooting

STEP	ACTION	RESPONSE	PROBABLE CAUSE
1	Remove jumper strap A1R149 and connect wiper of external $10\text{k}\Omega$ , 10-turn potentiometer (R148) to input of firing circuits (TP18). Set external pot to $-12.4\text{V}$ end. <i>Too positive an input will damage the SCR's.</i>		
2	Connect oscilloscope to A2Q1 base (TP22) and common (A7). Observe base waveform with external pot at $-12.4\text{V}$ end (blocking oscillator off).	a. Normal waveform (Figure 7-6). b. Abnormal waveform c. No waveform	a. Proceed to Step 3. b. Component in base circuit defective. Check A2C1, A2CR7, A2R3, etc. c. Fuse F4, F5, or F6 open. Base component open (A2R3, R4, etc.).
3	Connect oscilloscope to A2Q1 emitter (TP25) and terminal A7. Observe emitter waveform with external pot at $-12.4\text{V}$ end (blocking oscillator off).	a. Normal waveform (Figure 7-6) b. Waveform abnormal or missing.	a. Proceed to Step 4. b. Component is emitter circuit defective. Check A2C3, A2R7, and A2C1.
4	Leave scope connected to emitter of A2Q1 and slowly turn external pot toward $+12.4\text{V}$ end. When voltage at TP18 reaches about $-4\text{V}$ , first firing pulses should be generated. This is characterized by a negative going notch on the emitter waveform.	a. Normal waveform (Figure 7-6) b. Abnormal waveform	a. Proceed to Step 5. b. Check A2Q1 and associated components (A2T7, A2C2, A2R2). Check phase A SCR (CR4) for open.
5	Turn external pot to negative end and check waveform at base of A2Q2 (phase B stage), TP23.	a. Normal waveform b. Abnormal waveform	a. Proceed to Step 6. b. Component in A2Q2 base circuit defective or phase B portion of current balance circuit defective (check A1U4 and associated components).

Table 5-4. Firing Circuit Troubleshooting (Continued)

STEP	ACTION	RESPONSE	PROBABLE CAUSE
6	Repeat Step 3 except check waveform in A2Q2 emitter circuit (TP26).	a. Normal waveform b. Abnormal waveform	a. Proceed to Step 7. b. Component in emitter circuit defective. Check A2C13, A2R17, and A2C11.
7	Repeat Step 4 for firing of phase B blocking oscillator.	a. Normal waveform b. Abnormal waveform	a. Proceed to Step 8. b. Check A2Q2 and associated components. Check phase B SCR for open.
8	Check phase C base waveform (A2Q3, TP24). Turn external pot to negative end.	a. Normal waveform b. Abnormal waveform	a. Proceed to Step 9. b. Component in A2Q3 base circuit defective or phase C portion of current balance circuit defective (A1U5 and associated components).
9	Repeat Steps 3 and 4 except check phase C (A2Q3) waveforms.	a. Normal waveforms b. Abnormal waveform(s)	a. Firing circuit okay. b. Check applicable components in phase C stages.

#### 5-51 Crowbar Troubleshooting (Units with Option 006 Only)

5-52 Most crowbar faults fall into two general categories; (1) the circuit crowbars (CR37/CR38 fires) at all times even when the trip point is adjusted to maximum, or (2) the crowbar is completely inoperative at any trip point setting. Condition number one will result in zero (or very low) output voltage because the SCR crowbar will fire every time power is applied to the unit. For condition number two, no overvoltage protection is provided and the output voltage will go high if a failure occurs in the power supply protection circuits.

5-53 If condition one occurs (crowbar always fired), check all of the circuit transistors (A2Q7 through Q10) for possible shorts. Also check the crowbar SCR(s) itself for a short. If condition two occurs (crowbar inoperative), check transistors and SCR(s) for opens.

#### 5-54 REPAIR AND REPLACEMENT

5-55 Section VI of this manual contains a list of replaceable parts. If the part to be replaced does not have a standard manufacturers' part number, it is a "special" part and must be obtained directly from Hewlett-Packard. After replacing any semiconductor device, refer to the adjustment procedures outlined later in this Section.

#### 5-56 Air Filter

5-57 The air filter, located on the lower front panel, should be checked on a monthly basis and cleaned if necessary. To gain access to the filter, *turn off the unit* and remove the six mounting screws on the lower front panel (Figure 1-1). The filter is mounted by four screws in back of the lower front panel. With the filter removed access is also gained to the cooling fan.

#### 5-58 Hinged Front Panel

5-59 The upper portion of the front panel is hinged and can be dropped down for servicing the front panel components or the components on the front portion of the amplifier P.C. board, A1. To pull down the front panel, remove the two mounting screws on the sides of the front panel. Then grasp the top of the panel and pull out and down.

#### 5-60 Printed Circuit Boards

5-61 Figure 7-5 shows the location of the three main P.C. Boards (A1, A2, and A3) of the unit with the top cover removed. The amplifier board (A1) can be removed, if necessary, by the following procedures:

- a. Turn off unit and remove top cover.
- b. Pull down front panel (previous paragraph).
- c. To disconnect A1 board from two rear connectors

for A2 and A3 boards, grasp the two plastic tabs on front of A1 board and slide board forward until free of A2 and A3 board connectors.

d. To slide A1 board completely out of unit, it may be necessary to disconnect the front panel from its hinges.

e. To accomplish this, disconnect the front panel safety ground wire from its ground lug.

f. Next, snap out hinges supporting the front panel. Sufficient length in the front panel wiring is provided to enable this. Now slide the A1 board forward until clear of unit.

## 5-62 Primary SCR and Diode Replacement

5-63 The SCR regulators (CR1, CR2, CR3) or primary diodes (CR4, CR5, CR6) are mounted on top of the center heat sink running from front to rear of the unit. The top of these components are accessible from the top of the unit (Figure 7-5) and the bottom of the components can be reached from the rear or side of the unit. When replacing an SCR or diode, use Wakefield Type 120 (HP Part No. 6040-0239) thermal compound to obtain the proper heat conduction.

5-64 When fastening an SCR to the heat sink the use of a torque wrench is recommended. Too loose a torque may result in a poor connection between the SCR and heat sink. If the SCR is tightened too hard, the stud or nut may be stripped and the SCR itself could be broken.

5-65 The following list contains the torque recommendations for all of the SCR's used in the SCR-10 Series.

(1) SCR's with 1/4-inch mounting studs and nuts must be installed with a torque of approximately 20 inch-pounds.

(2) SCR's with 1/4-inch mounting studs without nuts (tapped heatsink) should be installed with a torque of approximately 30 inch-pounds.

(3) SCR's with 3/8-inch studs and nuts should be tightened to 110 inch-pounds.

(4) SCR's with 3/8-inch studs without nuts should be tightened to 140 inch-pounds.

## 5-66 Location of Power Transformer, Choke, Output Capacitors, and Secondary Rectifiers

5-67 All of these components can be reached by removing the side covers (see Figure 7-4). To remove the side covers, the top cover must be removed first. Then the side covers can be removed by pulling them up and away from unit. They are not fastened with mounting screws but are inserted into slots in the corner support posts.

## 5-68 Adjustment and Calibration

5-69 Adjustment and calibration may be required after performance testing or troubleshooting. The entire calibration

procedure should be performed after any semiconductor in the feedback loop is replaced. The adjustments are presented in the proper sequence and the entire procedure takes only about 15 minutes to accomplish.

## 5-70 Meter Zero

5-71 The pointer of each meter must rest on the zero calibration mark on the meter scale when the instrument is at normal operating temperature, resting in its normal operating position, and turned off. To zero set the meter proceed as follows:

a. Connect load resistor of value shown in Figure 5-1.

b. Turn on instrument and allow it to come up to normal operating temperature (about 30 minutes).

c. Turn instrument off. Wait one minute for power supply capacitors to discharge completely.

d. Insert sharp pointed object (pen point or awl) into small indentation near top of round black plastic disc located directly below meter face.

e. Rotate plastic disc clockwise until meter reads zero, then rotate counterclockwise slightly in order to free adjustment screw from meter suspension. Pointer should not move during latter part of adjustment.

## 5-72 Output Ripple, Preliminary Adjustment

5-73 Before making any further adjustments, it is essential to observe the output ripple to ascertain that all three SCR's are firing and that their conduction angles are approximately equal. Proceed as follows to make this check:

a. Connect ac coupled oscilloscope between +S and -S terminals.

b. Set VOLTAGE and CURRENT controls to mid-range.

c. Turn on supply with no load connected.

d. Observe output ripple (180Hz with no load) and ensure that all three phases are firing (no spaces between pulses) and that the peak amplitudes between adjacent pulses are roughly equal (within 25%) to each other.

e. If the ripple is unsatisfactory, adjust the phase B and C balance potentiometers A1R102 and A1R122 until the conditions of Step (d) are satisfied.

## 5-74 Constant Voltage Programming Accuracy

5-75 Zero Output Voltage. To calibrate the zero voltage programming accuracy, proceed as follows:

a. Connect differential voltmeter between +S and -S terminals.

b. Short-out VOLTAGE controls by connecting jumper between A2 and -S terminals.

c. Connect decade resistance box in place of A1R11.

d. Turn on supply and adjust decade box to obtain 0  $\pm$  10mVdc output on voltmeter.

e. Turn off supply and replace decade box with appropriate value resistor in A1R11 position.

#### 5-76 Voltage Programming Accuracy.

- Remove short between A2 and -S.
- Disconnect jumper between A2 and A3.
- Connect precision (0.1%) wire-wound resistance between A2 and -S terminals. Value shown below:

Model	Value (Ohms)	Output Voltage
6464C	1600	8
6466C	3600	18
6469C	7200	36
6472C	12.8k	64
6475C	22k	110
6477C	44k	220
6479C	60k	300
6483C	120k	600

d. Connect decade resistance box in place of A1R9 and turn on supply.

e. Adjust decade resistance to obtain rated output voltage  $\pm 1\%$ .

f. Adjustments for R9 and R11 may interact. Recheck for  $0 \pm 10\text{mVdc}$  output (Paragraph 5-75) and repeat R11 and R9 adjustments, if necessary.

g. Turn off supply and replace decade box with appropriate value resistance in R9 position.

h. Remove precision resistor and reinstall jumper between A2 and A3.

#### 5-77 Voltmeter Calibration

5-78 To calibrate the voltmeter, proceed as follows:

- Connect differential voltmeter across supply, observing correct polarity.
- Turn on supply and adjust VOLTAGE controls until differential voltmeter reads exactly the maximum rated output voltage.
- Adjust A1R144 until front panel voltmeter also indicates exactly the maximum rated output voltage.

#### 5-79 Overvoltage Protection Limit

5-80 The overvoltage limit sets the point at which the internal protection circuit (A1Q10) is activated. The adjustment is as follows:

- Connect differential voltmeter across +S and -S terminals.
- Turn on supply and set VOLTAGE controls fully cw.
- Voltmeter should read 110% of supply's rated output voltage.
- If it does not, turn off supply and connect decade resistance box in place of A1R83.
- Adjust decade box until output is 110% of rating and install proper resistor in R83 position.

#### 5-81 Constant Current Programming Accuracy

5-82 Zero Output Current. To calibrate the zero current programming accuracy, proceed as follows:

- Connect test setup shown on Figure 5-7.
- Short-out current controls by connecting jumper between terminals A4 and A6.
- Rotate VOLTAGE controls fully clockwise and turn on supply.
- Reading on differential voltmeter should be  $0 \pm 10\text{mV}$ .
- If it is not, shunt resistor A1R28 with a decade resistance box.
- Adjust decade resistance until differential voltmeter reads zero, then replace R28 with resistance value equal to that of decade resistance.

5-83 CC Programming Accuracy. To calibrate the constant current programming current, proceed as follows:

- Connect power supply as shown in Figure 5-7.
  - Remove strap between A5 and A6.
  - Connect a 0.1%, 1/8 Watt resistor between A4 and A6. Resistor value is as follows:
- | Model | Resistor Value (Ohms) | Rated Current (Amps) |
|-------|-----------------------|----------------------|
| 6464C | 200 $\Omega$          | 1000                 |
| 6466C | 200 $\Omega$          | 600                  |
| 6469C | 200 $\Omega$          | 300                  |
| 6472C | 225 $\Omega$          | 150                  |
| 6475C | 200 $\Omega$          | 100                  |
| 6477C | 200 $\Omega$          | 50                   |
| 6479C | 210 $\Omega$          | 35                   |
| 6483C | 250 $\Omega$          | 25                   |

d. Turn on supply and observe voltmeter reading. It should be voltage corresponding to rated output current  $\pm 1\%$  ( $50 \pm 0.5\text{mVdc}$  with a 50mV shunt).

- If it does not replace A1R25 with decade resistance box.
- Adjust decade resistance to obtain voltage corresponding to rated output current  $\pm 1\%$  on voltmeter.
- Replace decade box with equal value resistance in R25 position.
- Remove precision resistor and reinstall jumper between A5 and A6.

#### 5-84 Ammeter Calibration

5-85 To calibrate the ammeter, proceed as follows:

- Connect test setup shown in Figure 5-7.
- Turn VOLTAGE controls fully clockwise.
- Turn on supply and adjust CURRENT controls until differential voltmeter reads voltage corresponding to maximum rated output current.
- Adjust A1R141 until front panel ammeter indicates exactly maximum rated output current.

## 5-86 Backup Overcurrent

5-87 Proceed as follows to adjust the backup overcurrent limit:

- a. Connect test setup of Figure 5-7.
- b. Turn on supply and turn CURRENT controls fully cw.
- c. Voltmeter reading corresponds to 110% of maximum rated output current.
- d. If it does not, connect decade box in place of A1R37 and adjust to obtain 110%.
- e. Install resistor equal to decade box in R37 position.

## 5-88 Transient Recovery Time

5-89 To adjust the transient response, proceed as follows:

- a. Connect test setup as shown in Figure 5-4.
- b. Repeat Steps (a) through (d) as outlined in Paragraph 5-26.
- c. Adjust R48 so that the transient response waveform has a minimum of overshoot or oscillation and is within the tolerances of Figure 5-5.

## 5-90 Phase Protection

5-91 This adjustment establishes the low input line point at which the phase protection circuit becomes activated. Proceed as follows:

- a. Connect a 10kW, ac variac between ac input source and power supply line input.
- b. Connect an ac voltmeter between any ac input two phases.
- c. Turn on supply (no load connected) and rotate VOLTAGE controls for maximum rated output voltage.
- d. Using variac, reduce ac input line until power supply dc output voltage falls to near 0 volts. Record ac voltmeter reading at power supply turn-off point. It should read as follows:

<u>AC Line Voltage (Normal)</u>	<u>Line Voltage at Trip Point</u>
208	174 ± 6Vac
230	192 ± 6Vac
460	386 ± 13Vac

- e. If trip point is outside of tolerance, turn off supply and replace A1R77 with decade resistance box.
- f. Adjust decade box so that trip point of Step (d) is satisfied.
- g. Replace suitable value resistor in A1R77 position as determined by decade box setting.

## 5-92 Output Ripple, Final Adjustment

5-93 This adjustment balances the output ripple by balancing the ac line currents (phase B and C potentiometers A1R102 and A1R122). The method of adjustment depends on how closely the ac line-to-line voltages are balanced. If

the three phase line voltages are balanced to within 3% of each other, use the following adjustment procedure. If the line voltages are balanced to within 3% to 8% (maximum tolerable imbalance) of each other, use the second adjustment procedure.

5-94 Balance Adjustment (Line-to-Line Imbalance Within 3%). To make adjustment, proceed as follows:

- a. Connect oscilloscope between +S and -S terminals.
- b. Connect full load resistance (see Figure 5-1) across output bus bars.
- c. Turn on supply and adjust output voltage to about 20% of rating. Observe output ripple (360Hz with load) on scope.
- d. Peak amplitudes of adjacent ripple peaks should be equal to each other. If they are not, adjust A1R102 and A1R122.
- e. Increase output voltage in 10% steps adjusting R102 and R122 as necessary. Final adjustment is made at maximum rated output.

5-95 Balance Adjustment (Line-to-Line Imbalance 3 to 8%).

For this adjustment, the input line current is monitored rather than the output ripple. This adjustment ensures that the current balance circuit within the supply is operating in the center region of its operating curve thus providing protection for the ac input components in the supply. At the completion of the adjustment the input line currents will be balanced to within 3 to 5%. Output ripple will probably be imbalanced to some extent due to the line-to-line voltage imbalance of 3 to 8%. This adjustment is as follows:

- a. Attach ac clip-on ammeter to any one of the 3-phase input wires.
- b. Connect full load resistance across output (see Figure 5-1).
- c. Turn on supply and adjust output to about 10% of rating. Observe ac reading on ammeter.
- d. Attach clip-on ammeter to one of the other two phases and compare reading with that of Step (c). If the two currents are unequal, adjust A1R102 and A1R122.
- e. Set power supply output to 20% of rating and compare line currents of two of input phases. If unequal, adjust R102/R122.
- f. Continue to increase output voltage in 10% steps adjusting R102/R122, if necessary. Final adjustment is made at full rated output voltage.

## 5-96 Line Overcurrent Protection

5-97 This adjustment sets the trip point of the overcurrent protection portion of the overload circuit. When the trip point is exceeded, input power is removed and the OVERCURRENT PROTECT lamp on the front panel is illuminated. Proceed as follows:

- a. Connect dc voltmeter across A1C54 (between



emitter of A1Q11 and terminal A7).

b. Connect decade resistance box between +12.4V and emitter of A1Q11. Set decade box to 100k, initially.

c. Turn potentiometer A1R131 fully ccw.

d. Turn on supply (no load connected).

e. Decrease resistance of decade box until trip voltage read on dc voltmeter is as follows:

<u>Nominal Line (Vac)</u>	<u>Trip Voltage at A1Q11 Emitter</u>
208	$+7 \pm 0.1\text{Vdc}$
230	$+6.6 \pm 0.1\text{Vdc}$
380	$+7 \pm 0.1\text{Vdc}$
400	$+7 \pm 0.1\text{Vdc}$
460	$+6.6 \pm 0.1\text{Vdc}$

f. Adjust A1R131 until circuit trips and unit shuts

down.

g. Overload circuit is now adjusted. Remove decade box and operate supply normally.

#### NOTE

*For users with 208, 380, or 400Vac input lines, the supply may trip before the  $7 \pm 0.1\text{Vdc}$  trip voltage can be obtained. If this occurs, change A1R127 to  $20\text{k}\Omega$ ,  $\pm 1\%$ ,  $1/8\text{W}$  and adjust decade box for a trip voltage of  $+6.6 \pm 0.1\text{Vdc}$  (instead of  $7 \pm 0.1\text{Vdc}$ ) at emitter of A1Q11.*

## SECTION VI REPLACEABLE PARTS

### 6-1 INTRODUCTION

6-2 This section contains information for ordering replacement parts. Table 6-4 lists parts in alpha-numeric order by reference designators and provides the following information:

- a. Reference Designators. Refer to Table 6-1.
- b. Description. Refer to Table 6-2 for abbreviations.
- c. Total Quantity (TQ). Given only the first time the part number is listed except in instruments containing many sub-modular assemblies, in which case the TQ appears the first time the part number is listed in each assembly.
- d. Manufacturer's Part Number or Type.
- e. Manufacturer's Federal Supply Code Number. Refer to Table 6-3 for manufacturer's name and address.
- f. Hewlett-Packard Part Number.
- g. Recommended Spare Parts Quantity (RS) for complete maintenance of one instrument during one year of isolated service.
- h. Parts not identified by a reference designator are listed at the end of Table 6-4 under Mechanical and/or Miscellaneous. The former consists of parts belonging to and grouped by individual assemblies; the latter consists of all parts not immediately associated with an assembly.

### 6-3 ORDERING INFORMATION

6-4 To order a replacement part, address order or inquiry to your local Hewlett-Packard sales office (see lists at rear of this manual for addresses). Specify the following information for each part: Model, complete serial number, and any Option or special modification (J) numbers of the instrument; Hewlett-Packard part number; circuit reference designator; and description. To order a part not listed in Table 6-4, give a complete description of the part, its function, and its location.

Table 6-1. Reference Designators

A	= assembly	E	= miscellaneous
B	= blower (fan)		electronic part
C	= capacitor	F	= fuse
CB	= circuit breaker	J	= jack, jumper
CR	= diode	K	= relay
DS	= device, signaling (lamp)	L	= inductor
		M	= meter

Table 6-1. Reference Designators (Continued)

P	= plug	V	= vacuum tube, neon bulb, photocell, etc.
Q	= transistor	VR	= zener diode
R	= resistor	X	= socket
S	= switch	Z	= integrated circuit or network
T	= transformer		
TB	= terminal block		
TS	= thermal switch		

Table 6-2. Description Abbreviations

A	= ampere	mfr	= manufacturer
ac	= alternating current	mod.	= modular or modified
assy.	= assembly	mtg	= mounting
bd	= board	n	= nano = $10^{-9}$
bkt	= bracket	NC	= normally closed
°C	= degree Centigrade	NO	= normally open
cd	= card	NP	= nickel-plated
coef	= coefficient	Ω	= ohm
comp	= composition	obd	= order by description
CRT	= cathode-ray tube	OD	= outside diameter
CT	= center-tapped	p	= pico = $10^{-12}$
dc	= direct current	P.C.	= printed circuit
DPDT	= double pole, double throw	pot.	= potentiometer
DPST	= double pole, single throw	p-p	= peak-to-peak
elect	= electrolytic	ppm	= parts per million
encap	= encapsulated	pvr	= peak reverse voltage
F	= farad	rect	= rectifier
°F	= degree Fahrenheit	rms	= root mean square
fxd	= fixed	Si	= silicon
Ge	= germanium	SPDT	= single pole, double throw
H	= Henry	SPST	= single pole, single throw
Hz	= Hertz	SS	= small signal
IC	= integrated circuit	T	= slow-blow
ID	= inside diameter	tan.	= tantalum
incnd	= incandescent	Ti	= titanium
k	= kilo = $10^3$	V	= volt
m	= milli = $10^{-3}$	var	= variable
M	= mega = $10^6$	ww	= wirewound
μ	= micro = $10^{-6}$	W	= Watt
met.	= metal		

Table 6-3. Code List of Manufacturers

CODE NO.	MANUFACTURER	ADDRESS
00629	EBY Sales Co., Inc.	Jamaica, N. Y.
00656	Aerovox Corp.	New Bedford, Mass.
00853	Sangamo Electric Co.	
	S. Carolina Div.	Pickens, S. C.
01121	Allen Bradley Co.	Milwaukee, Wis.
01255	Litton Industries, Inc.	Beverly Hills, Calif.
01281	TRW Semiconductors, Inc.	Lawndale, Calif.
01295	Texas Instruments, Inc.	
	Semiconductor-Components Div.	Dallas, Texas
01686	RCL Electronics, Inc.	Manchester, N. H.
01930	Amerock Corp.	Rockford, Ill.
02107	Sparta Mfg. Co.	Dover, Ohio
02114	Ferroxcube Corp.	Saugerties, N. Y.
02606	Fenwal Laboratories	Morton Grove, Ill.
02660	Amphenol Corp.	Broadview, Ill.
02735	Radio Corp. of America, Solid State and Receiving Tube Div.	Somerville, N. J.
03508	G. E. Semiconductor Products Dept.	Syracuse, N. Y.
03797	Eldema Corp.	Compton, Calif.
03877	Transitron Electronic Corp.	Wakefield, Mass.
03888	Pyrofilm Resistor Co. Inc.	Cedar Knolls, N. J.
04009	Arrow, Hart and Hegeman Electric Co.	Hartford, Conn.
04072	ADC Electronics, Inc.	Harbor City, Calif.
04213	Caddell & Burns Mfg. Co. Inc.	Mineola, N. Y.
04404	*Hewlett-Packard Co.	Palo Alto Div. Palo Alto, Calif.
04713	Motorola Semiconductor Prod. Inc.	Phoenix, Arizona
05277	Westinghouse Electric Corp.	
	Semiconductor Dept.	Youngwood, Pa.
05347	Ultronix, Inc.	Grand Junction, Colo.
05820	Wakefield Engr. Inc.	Wakefield, Mass.
06001	General Elect. Co. Electronic Capacitor & Battery Dept.	Irmo, S. C.
06004	Bassik Div. Stewart-Warner Corp.	Bridgeport, Conn.
06486	IRC Div. of TRW Inc.	
	Semiconductor Plant	Lynn, Mass.
06540	Amatom Electronic Hardware Co. Inc.	New Rochelle, N. Y.
06555	Beede Electrical Instrument Co.	Penacook, N. H.
06666	General Devices Co. Inc.	Indianapolis, Ind.
06751	Semcor Div. Components, Inc.	Phoenix, Arizona
06776	Robinson Nugent, Inc.	New Albany, Ind.
06812	Torrington Mfg. Co., West Div.	Van Nuys, Calif.
07137	Transistor Electronics Corp.	Minneapolis, Minn.

CODE NO.	MANUFACTURER	ADDRESS
07138	Westinghouse Electric Corp.	
	Electronic Tube Div.	Elmira, N. Y.
07263	Fairchild Camera and Instrument Corp. Semiconductor Div.	Mountain View, Calif.
07387	Bircher Corp., The	Los Angeles, Calif.
07397	Sylvania Electric Prod. Inc.	
	Sylvania Electronic Systems Western Div.	Mountain View, Calif.
07716	IRC Div. of TRW Inc.	Burlington Plant Burlington, Iowa
07910	Continental Device Corp.	Hawthorne, Calif.
07933	Raytheon Co. Components Div. Semiconductor Operation	Mountain View, Calif.
08484	Breeze Corporations, Inc.	Union, N. J.
08530	Reliance Mica Corp.	Brooklyn, N. Y.
08717	Sloan Company, The	Sun Valley, Calif.
08730	Vemaline Products Co. Inc.	Wyckoff, N. J.
08806	General Elect. Co. Minia- ture Lamp Dept.	Cleveland, Ohio
08863	Nylomatic Corp.	Norrisville, Pa.
08919	RCH Supply Co.	Vernon, Calif.
09021	Airco Speer Electronic Components	Bradford, Pa.
09182	*Hewlett-Packard Co.	New Jersey Div. Rockaway, N. J.
09213	General Elect. Co. Semiconductor Prod. Dept.	Buffalo, N. Y.
09214	General Elect. Co. Semiconductor Prod. Dept.	Auburn, N. Y.
09353	C & K Components Inc.	Newton, Mass.
09922	Burndy Corp.	Norwalk, Conn.
11115	Wagner Electric Corp.	
	Tung-Sol Div.	Bloomfield, N. J.
11236	CTS of Berne, Inc.	Berne, Ind.
11237	Chicago Telephone of Cal. Inc.	So. Pasadena, Calif.
11502	IRC Div. of TRW Inc.	Boone Plant Boone, N. C.
11711	General Instrument Corp Rectifier Div.	Newark, N. J.
12136	Philadelphia Handle Co. Inc.	Camden, N. J.
12615	U. S. Terminals, Inc.	Cincinnati, Ohio
12617	Hamlin Inc.	Lake Mills, Wisconsin
12697	Clarostat Mfg. Co. Inc.	Dover, N. H.
13103	Thermalloy Co.	Dallas, Texas
14493	*Hewlett-Packard Co.	Loveland Div. Loveland, Colo.
14655	Cornell-Dubilier Electronics Div. Federal Pacific Electric Co.	Newark, N. J.
14936	General Instrument Corp. Semicon- ductor Prod. Group	Hicksville, N. Y.
15801	Fenwal Elect.	Framingham, Mass.
16299	Corning Glass Works, Electronic Components Div.	Raleigh, N. C.

\*Use Code 28480 assigned to Hewlett-Packard Co., Palo Alto, California

Table 6-3. Code List of Manufacturers (Continued)

CODE NO.	MANUFACTURER	ADDRESS
16758	Delco Radio Div. of General Motors Corp.	Kokomo, Ind.
17545	Atlantic Semiconductors, Inc.	Asbury Park, N. J.
17803	Fairchild Camera and Instrument Corp Semiconductor Div. Transducer Plant	Mountain View, Calif.
17870	Daven Div. Thomas A. Edison Industries McGraw-Edison Co.	Orange, N. J.
18324	Signetics Corp.	Sunnyvale, Calif.
19315	Bendix Corp. The Navigation and Control Div.	Teterboro, N. J.
19701	Electra/Midland Corp.	Mineral Wells, Texas
21520	Fansteel Metallurgical Corp.	No. Chicago, Ill.
22229	Union Carbide Corp. Electronics Div.	Mountain View, Calif.
22753	UID Electronics Corp.	Hollywood, Fla.
23936	Pamotor, Inc.	Pampa, Texas
24448	General Electric Co.	Schenectady, N. Y.
24455	General Electric Co. Lamp Div. of Con- sumer Prod. Group	Nela Park; Cleveland, Ohio
24655	General Radio Co.	West Concord, Mass.
24681	LTV Electrosystems Inc Memcor/Com- ponents Operations	Huntington, Ind.
26982	Dynacool Mfg. Co. Inc.	Saugerties, N. Y.
27014	National Semiconductor Corp.	Santa Clara, Calif.
28480	Hewlett-Packard Co.	Palo Alto, Calif.
28520	Heyman Mfg. Co.	Kenilworth, N. J.
28875	IMC Magnetics Corp. New Hampshire Div.	Rochester, N. H.
31514	SAE Advance Packaging, Inc.	Santa Ana, Calif.
31827	Budwig Mfg. Co.	Ramona, Calif.
33173	G. E. Co. Tube Dept.	Owensboro, Ky.
35434	Lectrohm, Inc.	Chicago, Ill.
37942	P. R. Mallory & Co. Inc.	Indianapolis, Ind.
42190	Muter Co.	Chicago, Ill.
43334	New Departure-Hyatt Bearings Div. General Motors Corp.	Sandusky, Ohio
44655	Ohmite Manufacturing Co.	Skokie, Ill.
46384	Penn Engr. and Mfg. Corp.	Doylestown, Pa.
47904	Polaroid Corp.	Cambridge, Mass.
49956	Raytheon Co.	Lexington, Mass.
55026	Simpson Electric Co. Div. of American Gage and Machine Co.	Chicago, Ill.
56289	Sprague Electric Co.	North Adams, Mass.
58474	Superior Electric Co.	Bristol, Conn.
58849	Syntron Div. of FMC Corp.	Homer City, Pa.
59730	Thomas and Betts Co.	Philadelphia, Pa.
61637	Union Carbide Corp.	New York, N. Y.
63743	Ward Leonard Electric Co.	Mt. Vernon, N. Y.

CODE NO.	MANUFACTURER	ADDRESS
70563	Amperite Co. Inc.	Union City, N. J.
70901	Beemer Engrg. Co.	Fort Washington, Pa.
70903	Belden Corp.	Chicago, Ill.
71218	Bud Radio, Inc.	Willoughby, Ohio
71279	Cambridge Thermionic Corp.	Cambridge, Mass.
71400	Bussmann Mfg. Div. of McGraw & Edison Co.	St. Louis, Mo.
71450	CTS Corp.	Elkhart, Ind.
71468	I. T. T. Cannon Electric Inc.	Los Angeles, Calif.
71590	Globe-Union Inc. Centralab Div.	Milwaukee, Wis.
71700	General Cable Corp. Cornish Wire Co. Div.	Williamstown, Mass.
71707	Coto Coil Co. Inc.	Providence, R. I.
71744	Chicago Miniature Lamp Works	Chicago, Ill.
71785	Cinch Mfg. Co. and Howard B. Jones Div.	Chicago, Ill.
71984	Dow Corning Corp.	Midland, Mich.
72136	Electro Motive Mfg. Co. Inc.	Willimantic, Conn.
72619	Dialight Corp.	Brooklyn, N. Y.
72699	General Instrument Corp.	Newark, N. J.
72765	Drake Mfg. Co.	Harwood Heights, Ill.
72962	Elastic Stop Nut Div. of Amerace Esna Corp.	Union, N. J.
72982	Erie Technological Products Inc.	Erie, Pa.
73096	Hart Mfg. Co.	Hartford, Conn.
73138	Beckman Instruments Inc. Helipot Div.	Fullerton, Calif.
73168	Fenwal, Inc.	Ashland, Mass.
73293	Hughes Aircraft Co. Electron Dynamics Div.	Torrance, Calif.
73445	Amperex Electronic Corp.	Hicksville, N. Y.
73506	Bradley Semiconductor Corp.	New Haven, Conn.
73559	Carling Electric, Inc.	Hartford, Conn.
73734	Federal Screw Products, Inc.	Chicago, Ill.
74193	Heinemann Electric Co.	Trenton, N. J.
74545	Hubbell Harvey Inc.	Bridgeport, Conn.
74868	Amphenol Corp. Amphenol RF Div.	Danbury, Conn.
74970	E. F. Johnson Co.	Waseca, Minn.
75042	IRC Div. of TRW, Inc.	Philadelphia, Pa.
75183	*Howard B. Jones Div. of Cinch Mfg. Corp.	New York, N. Y.
75376	Kurz and Kasch, Inc.	Dayton, Ohio
75382	Kilka Electric Corp.	Mt. Vernon, N. Y.
75915	Littlefuse, Inc.	Des Plaines, Ill.
76381	Minnesota Mining and Mfg. Co.	St. Paul, Minn.
76385	Minor Rubber Co. Inc.	Bloomfield, N. J.
76487	James Millen Mfg. Co. Inc.	Malden, Mass.
76493	J. W. Miller Co.	Compton, Calif.

\*Use Code 71785 assigned to Cinch Mfg. Co., Chicago, Ill.

Table 6-3. Code List of Manufacturers (Continued)

CODE NO.	MANUFACTURER	ADDRESS
76530	Cinch	City of Industry, Calif.
76854	Oak Mfg. Co. Div. of Oak	
77068	Electro/Netics Corp.	Crystal Lake, Ill.
	Bendix Corp., Electrodynamics Div.	
		No. Hollywood, Calif.
77122	Palnut Co.	Mountainside, N. J.
77147	Patton-MacGuyer Co.	Providence, R. I.
77221	Phaostron Instrument and Electronic Co.	South Pasadena, Calif.
77252	Philadelphia Steel and Wire Corp.	
		Philadelphia, Pa.
77342	American Machine and Foundry Co.	
	Potter and Brumfield Div.	Princeton, Ind.
77630	TRW Electronic Components Div.	
		Camden, N. J.
77764	Resistance Products Co.	Harrisburg, Pa.
78189	Illinois Tool Works Inc.	Shakeproof Div.
		Elgin, Ill.
78452	Everlock Chicago, Inc.	Chicago, Ill.
78488	Stackpole Carbon Co.	St. Marys, Pa.
78526	Stanwyck Winding Div.	San Fernando
	Electric Mfg. Co. Inc.	Newburgh, N. Y.
78553	Tinnerman Products, Inc.	Cleveland, Ohio
78584	Stewart Stamping Corp.	Yonkers, N. Y.
79136	Waldes Kohinoor, Inc.	L. I. C., N. Y.
79307	Whitehead Metals Inc.	New York, N. Y.
79727	Continental-Wirt Electronics Corp.	
		Philadelphia, Pa.
79963	Zierick Mfg. Co.	Mt. Kisco, N. Y.
80031	Mepco Div. of Sessions Clock Co.	
		Morristown, N. J.
80294	Bourns, Inc.	Riverside, Calif.
81042	Howard Industries Div. of Msl Ind. Inc.	
		Racine, Wisc.
81073	Grayhill, Inc.	La Grange, Ill.
81483	International Rectifier Corp.	
		El Segundo, Calif.
81751	Columbus Electronics Corp.	Yonkers, N. Y.
82099	Goodyear Sundries & Mechanical Co. Inc.	New York, N. Y.
82142	Airco Speer Electronic Components	
		Du Bois, Pa.
82219	Sylvania Electric Products Inc.	
	Electronic Tube Div. Receiving	
	Tube Operations	Emporium, Pa.
82389	Switchcraft, Inc.	Chicago, Ill.
82647	Metals and Controls Inc. Control	
	Products Group	Attleboro, Mass.
82866	Research Products Corp.	Madison, Wis.
82877	Rotron Inc.	Woodstock, N. Y.
82893	Vector Electronic Co.	Glendale, Calif.
83058	Carr Fastener Co.	Cambridge, Mass.
83186	Victory Engineering Corp.	
		Springfield, N. J.
83298	Bendix Corp. Electric Power Div.	
		Eatontown, N. J.
83330	Herman H. Smith, Inc.	Brooklyn, N. Y.
83385	Central Screw Co.	Chicago, Ill.
83501	Gavitt Wire and Cable Div. of	
	Amerace Esna Corp.	Brookfield, Mass.

CODE NO.	MANUFACTURER	ADDRESS
83508	Grant Pulley and Hardware Co.	West Nyack, N. Y.
83594	Burroughs Corp. Electronic	
	Components Div.	Plainfield, N. J.
83835	U. S. Radium Corp.	Morristown, N. J.
83877	Yardeny Laboratories, Inc.	
		New York, N. Y.
84171	Arco Electronics, Inc.	Great Neck, N. Y.
84411	TRW Capacitor Div.	Ogallala, Neb.
86684	RCA Corp. Electronic Components	
		Harrison, N. J.
86838	Rummel Fibre Co.	Newark, N. J.
87034	Marco & Oak Industries a Div. of Oak	
	Electro/netics Corp.	Anahelm, Calif.
87216	Philco Corp. Lansdale Div.	Lansdale, Pa.
87585	Stockwell Rubber Co. Inc.	
		Philadelphia, Pa.
87929	Tower-Olschan Corp.	Bridgeport, Conn.
88140	Cutler-Hammer Inc. Power Distribution	
	and Control Div. Lincoln Plant	Lincoln, Ill.
88245	Litton Precision Products Inc, USECO	
	Div. Litton Industries	Van Nuys, Calif.
90634	Gulton Industries Inc.	Metuchen, N. J.
90763	United-Car Inc.	Chicago, Ill.
91345	Miller Dial and Nameplate Co.	
		El Monte, Calif.
91418	Radio Materials Co.	Chicago, Ill.
91506	Augat, Inc.	Attleboro, Mass.
91637	Dale Electronics, Inc.	Columbus, Neb.
91662	Elco Corp.	Willow Grove, Pa.
91929	Honeywell Inc. Div. Micro Switch	
		Freeport, Ill.
92825	Whitso, Inc.	Schiller Pk., Ill.
93332	Sylvania Electric Prod. Inc. Semi-	
	conductor Prod. Div.	Woburn, Mass.
93410	Essex Wire Corp. Stemco	
	Controls Div.	Mansfield, Ohio
94144	Raytheon Co. Components Div.	
	Ind. Components Oper.	Quincy, Mass.
94154	Wagner Electric Corp.	
	Tung-Sol Div.	Livingston, N. J.
94222	Southco Inc.	Lester, Pa.
95263	Leecraft Mfg. Co. Inc.	L. I. C., N. Y.
95354	Methode Mfg. Co.	Rolling Meadows, Ill.
95712	Bendix Corp. Microwave	
	Devices Div.	Franklin, Ind.
95987	Weckesser Co. Inc.	Chicago, Ill.
96791	Amphenol Corp. Amphenol	
	Controls Div.	Janesville, Wis.
97464	Industrial Retaining Ring Co.	
		Irvington, N. J.
97702	IMC Magnetics Corp. Eastern Div.	
		Westbury, N. Y.
98291	Sealectro Corp.	Mamaroneck, N. Y.
98410	ETC Inc.	Cleveland, Ohio
98978	International Electronic Research Corp.	
		Burbank, Calif.
99934	Renbrandt, Inc.	Boston, Mass.

Table 6-4. Replaceable Parts

REF. DESIG.	DESCRIPTION	TQ	MFR. PART NO.	MFR. CODE	HP PART NO.	RS
A1	Amplifier Board	1		28480	06469-60021	
C1	fxd, mylar 0.022 $\mu$ F 200Vdc	1	192P22292	56289	0160-0162	1
C2	fxd, mylar 0.1 $\mu$ F 200Vdc	3	192P10492	56289	0160-0168	1
C5	fxd, ceramic 0.02 $\mu$ F 2000Vdc	2		28480	0160-2569	1
C6	fxd, tantalum 1 $\mu$ F 35Vdc	2	150D105X9035A2	56289	0180-0291	1
C8	fxd, ceramic 0.015 $\mu$ F 1000V	1		28480	0160-2477	1
C10	fxd, tantalum 1 $\mu$ F 35Vdc		150D105X9035A2	56289	0180-0291	
C11	fxd, ceramic 0.02 $\mu$ F 2000Vdc			28480	0160-2569	
C12	fxd, ceramic 0.47 $\mu$ F 25Vdc	4		28480	0160-0174	1
C15	fxd, tantalum 4.7 $\mu$ F 35Vdc	4	150D475X9035B2	56289	0180-0100	1
C16	fxd, ceramic 0.02 $\mu$ F 600Vdc	1	841-000-Z5U-2032	72982	0150-0024	1
C17	fxd, ceramic 0.01 $\mu$ F 500Vdc	4		28480	0150-0081	1
C18	fxd, tantalum 4.7 $\mu$ F 35Vdc		150D475X9035B2	56289	0180-0100	
C19	fxd, ceramic 0.47 $\mu$ F 25Vdc			28480	0160-0174	
C20	fxd, tantalum 15 $\mu$ F 50Vdc	1	150D156X0050R2	56289	0180-1834	1
C21	fxd, ceramic 0.01 $\mu$ F 500Vdc			28480	0150-0081	
C22	fxd, mylar 0.22 $\mu$ F 80Vdc	1	192P2249R8	56289	0160-2453	1
C23	fxd, tantalum 68 $\mu$ F 15V	7	150D686X0015B2	56289	0180-1835	2
C25	fxd, elect. 200 $\mu$ F 65V	1		28480	0180-1884	1
C26	fxd, tantalum 4.7 $\mu$ F 35Vdc		150D475X9035B2	56289	0180-0100	
C27	fxd, tantalum 68 $\mu$ F 15V		150D686X0015B2	56289	0180-1835	
C28	fxd, tantalum 22 $\mu$ F 35V	1	150D226X0035R2	56289	0180-0160	1
C30	fxd, elect. 1 $\mu$ F 50V	1	30D105G050BA2	56289	0180-0108	1
C31	fxd, ceramic 0.47 $\mu$ F 25Vdc			28480	0160-0174	
C34,35	fxd, tantalum 68 $\mu$ F 15V		150D686X0015B2	56289	0180-1835	
C36	fxd, mica 30pF 300Vdc	2	RCM15E300J3C	00853	0160-2199	1
C38	fxd, mylar 0.1 $\mu$ F 200Vdc		192P10492	56289	0160-0168	
C39	fxd, ceramic 0.01 $\mu$ F 500Vdc			28480	0150-0081	
C44,45	fxd, tantalum 68 $\mu$ F 15V		150D686X0015B2	56289	0180-1835	
C46	fxd, mica 30pF 300Vdc		RDM15E300J3C	00853	0160-2199	
C48	fxd, mylar 0.1 $\mu$ F 200Vdc		192P10492	56289	0160-0168	
C49	fxd, ceramic 0.01 $\mu$ F 500Vdc			28480	0150-0081	
C52	fxd, ceramic 0.47 $\mu$ F 25Vdc			28480	0160-0174	
C53	fxd, tantalum 68 $\mu$ F 15V		150D686X0015B2	56289	0180-1835	
C54	fxd, tantalum 4.7 $\mu$ F 35Vdc		150D475X9035B2	56289	0180-0100	
C55	fxd, elect. 1450 $\mu$ F 45V	1		28480	0180-1893	1
CR1,2,13-16	Diode, Si. 250mW 200V	25		28480	1901-0033	10
CR19,20	Stabistor 400mW 10V	7		28480	1901-0460	6
CR21	Diode, Si. 250mW 200V			28480	1901-0033	
CR22	Stabistor 400mW 10V			28480	1901-0460	
CR23-25	Diode, Si. 250mW 200V			28480	1901-0033	
CR26	Stabistor 400mW 10V			28480	1901-0460	
CR27	Diode, Si. 250mW 200V			28480	1901-0033	
CR28-33	Rectifier, Si. 200V 1A	10		28480	1901-0327	7
CR34	Diode, Si. 250mW 200V			28480	1901-0033	
CR35	Stabistor 400mW 10V			28480	1901-0460	
CR38-41,43, 45-48,50-53	Diode, Si. 250mW 200V			28480	1901-0033	
CR54-57	Rectifier, Si. 200V 1A			28480	1901-0327	

REF. DESIG.	DESCRIPTION†	TQ	MFR. PART NO.	MFR. CODE	HP PART NO.	RS
A1CR58	SCR 600V 2A	1		28480	1884-0044	1
CR60,61	Stabistor 400mW 10V			28480	1901-0460	
K1	Relay, 4 PDT	1	KHP-17D11-24	77342	0490-0364	1
Q1	SS NPN Si.	3		28480	1854-0244	3
Q2,3	SS NPN Si.	2		28480	1854-0087	2
Q4	SS PNP Si.	1		28480	1853-0010	1
Q5	SS NPN Si.	1		28480	1854-0224	1
Q6-8	SS PNP Si.	3		28480	1853-0041	3
Q9,10	SS NPN Si.			28480	1854-0244	
Q11	Unijunction, Si. SS	1	2N2646	04713	1855-0010	1
R1,2	fxd, met. film 23k 1% 1/8W	2	Type CEA T-0	07716	0698-3269	1
R6,8	fxd, ww 820 3W TC ±30ppm/°C	2	242E8215	56289	0813-0010	1
R9	fxd, met. film 6k 1% 1/8W	2	Type CEA T-0	07716	0698-3476	1
R10	fxd, met. film 2k 1% 1/8W	3	Type CEA T-0	07716	0757-0283	1
R11	fxd, comp 18k 5% 1/2W	3	EB-1835	01121	0686-1835	1
R12	fxd, comp 3.9k 5% 1/2W	2	EB-3925	01121	0686-3925	1
R13	fxd, met. film 6.2k 1% 1/8W	6	Type CEA T-0	07716	0698-5087	2
R14	fxd, met. film 8.25k 1% 1/8W	5	Type CEA T-0	07716	0757-0441	1
R15	fxd, comp 560 5% 1/2W	1	EB-5615	01121	0686-5615	1
R25	fxd, met. film 160k 1% 1/8W	1	Type CEA T-0	07716	0698-5092	1
R26	fxd, met. film 29.9k 1% 1/2W	1	Type CCA T-0	07716	0698-5151	1
R27	fxd, met. film 2k 1% 1/8W		Type CEA T-0	07716	0757-0283	
R28	fxd, comp 18k 5% 1/2W		EB-1835	01121	0686-1835	
R29	fxd, met. film 6.2k 1% 1/8W		Type CEA T-0	07716	0698-5087	
R30	fxd, met. film 8.25k 1% 1/8W		Type CEA T-0	07716	0757-0441	
R32,33	fxd, comp 1k 5% 1/2W	7	EB-1025	01121	0686-1025	2
R34	fxd, met. film 8.25k 1% 1/8W		Type CEA T-0	07716	0757-0441	
R37	fxd, met. film 6k 1% 1/8W		Type CEA T-0	07716	0698-3476	
R38	fxd, met. film 1.69k 1% 1/8W	1	Type CEA T-0	07716	0698-4428	1
R39	fxd, comp 1k 5% 1/2W		EB-1025	01121	0686-1025	
R40	fxd, met. film 2k 1% 1/8W		Type CEA T-0	07716	0757-0283	
R41	fxd, met. film 8.25k 1% 1/8W		Type CEA T-0	07716	0757-0441	
R42	fxd, met. film 6.2k 1% 1/8W		Type CEA T-0	07716	0698-5087	
R43	fxd, met. film 23.7k 1% 1/2W	1	Type CEC T-0	07716	0698-3417	1
R44	fxd, comp 1.3k 5% 1/2W	2	EB-1325	01121	0686-1325	1
R45	fxd, comp 36k 5% 1/2W	1	EB-3635	01121	0686-3635	1
R46	fxd, comp 39k 5% 1/2W	2	EB-3935	01121	0686-3935	1
R48	var. ww 15k 5% Single-Turn	3	Type CT-100-4	07716	2100-0896	1
R49	fxd, comp 3.9k 5% 1/2W		EB-3925	01121	0686-3925	
R50	fxd, comp 43k 5% 1/2W	2	EB-4335	01121	0686-4335	1
R51	fxd, comp 390 5% 1/2W	1	EB-3915	01121	0686-3915	1
R52	fxd, comp 120 5% 1/2W	1	EB-1215	01121	0686-1215	1
R53	fxd, comp 2k 5% 1/2W	3	EB-2025	01121	0686-2025	1
R54	fxd, comp 100 5% 1/2W	1	EB-1015	01121	0686-1015	1
R55	fxd, met. film 6.2k 1% 1/8W		Type CEA T-0	07716	0698-5087	
R56	fxd, comp 1k 5% 1/2W		EB-1025	01121	0686-1025	
R57	fxd, comp 39k 5% 1/2W		EB-3935	01121	0686-3935	
R60	fxd, ww 2.7 5% 2W	1	Type BWH	07716	0811-1671	1
R61	fxd, comp 2.4k 5% 1/2W	1	EB-2425	01121	0686-2425	1
R62	fxd, comp 1.5k 5% 1/2W	1	EB-1525	01121	0686-1525	1
R63	fxd, comp 1.8k 5% 1/2W	1	EB-1825	01121	0686-1825	1

†NOTE: All resistors are in ohms unless otherwise indicated.

REF. DESIG.	DESCRIPTION†	TQ	MFR. PART NO.	MFR. CODE	HP PART NO.	RS
A1R64	fxd, met. film 12k 1% 1/8W	3	Type CEA T-0	07716	0698-5088	1
R65	fxd, met. film 8.25k 1% 1/8W		Type CEA T-0	07716	0757-0441	
R66	fxd, ww 634 1% 1/4W TC ±20ppm/°C	1		28480	0811-1934	1
R67	fxd, comp 10 5% 1/2W	1	EB-1005	01121	0686-1005	1
R68	fxd, comp 470 5% 1/2W	1	EB-4715	01121	0686-4715	1
R69	fxd, met. film 12k 1% 1/8W		Type CEA T-0	07716	0698-5088	
R70,71	fxd, met. film 6.2k 1% 1/8W		Type CEA T-0	07716	0698-5087	
R75	fxd, comp 1.3k 5% 1/2W		EB-1325	01121	0686-1325	
R76	fxd, met. oxide 5.1k 5% 2W	1	Type C42S	16299	0698-3644	1
R77	fxd, comp 2.7k 5% 1/2W	1	EB-2725	01121	0686-2725	1
R78	fxd, comp 180 5% 1/2W	1	EB-1815	01121	0686-1815	1
R79	fxd, comp 620 5% 1/2W	1	EB-6215	01121	0686-6215	1
R80	fxd, comp 10k 5% 1/2W	1	EB-1035	01121	0686-1035	1
R83	fxd, comp 30k 5% 1/2W	2	EB-3035	01121	0686-3035	1
R84	fxd, comp 15k 5% 1/2W	1	EB-1535	01121	0686-1535	1
R85	fxd, comp 43k 5% 1/2W	1	EB-4335	01121	0686-4335	1
R86	fxd, met. oxide 27k 5% 2W	2	Type C42S	16299	0764-0007	1
R90§,91§	fxd, met. oxide 22 5% 2W	4	Type C42S	16299	0698-3609	1
R92,93	fxd, met. film 9.09k 1% 1/8W	4	Type CEA T-0	07716	0757-0288	1
R94,95	fxd, met. film 7.5k 1% 1/8W	4	Type CEA T-0	07716	0757-0440	1
R96	fxd, comp 1k 5% 1/2W		EB-1025	01121	0686-1025	
R98	fxd, comp 330 5% 1/2W	2	EB-3315	01121	0686-3315	1
R99	fxd, comp 75k 5% 1/2W	2	EB-7535	01121	0686-7535	1
R100	fxd, met. film 15k 1% 1/8W	2	Type CEA T-0	07716	0757-0446	1
R101	fxd, comp 1 Meg 5% 1/2W	2	EB-1055	01121	0686-1055	1
R102	var. ww 15k 5% Single-Turn		Type CT-100-4	07716	2100-0896	
R110§,111§	fxd, met. oxide 22 5% 2W		Type C42S	16299	0698-3609	
R112,113	fxd, met. film 9.09k 1% 1/8W		Type CEA T-0	07716	0757-0288	
R114,115	fxd, met. film 7.5k 1% 1/8W		Type CEA T-0	07716	0757-0440	
R116	fxd, comp 1k 5% 1/2W		EB-1025	01121	0686-1025	
R118	fxd, comp 330 5% 1/2W		EB-3315	01121	0686-3315	
R119	fxd, comp 75k 5% 1/2W		EB-7535	01121	0686-7535	
R120	fxd, met. film 15k 1% 1/8W		Type CEA T-0	07716	0757-0446	
R121	fxd, comp 1 Meg 5% 1/2W		EB-1055	01121	0686-1055	
R122	var. ww 15k 5% Single-Turn		Type CT-100-4	07716	2100-0896	
R125,126	fxd, comp 2k 5% 1/2W		EB-2025	01121	0686-2025	
R127	fxd, met. film 12k 1% 1/8W		Type CEA T-0	07716	0698-5088	
R128	fxd, comp 100k 5% 1/2W	1	EB-1045	01121	0686-1045	1
R129	fxd, comp 1k 5% 1/2W		EB-1025	01121	0686-1025	
R130	fxd, met. film 4.32k 1% 1/8W	1	Type CEA T-0	07716	0757-0436	1
R131	var. ww 2k 5% Single-Turn	1	Type CT-100-4	07716	2100-1429	1
R133,134	fxd, ww 400 5% 10W TC ±30ppm/°C	2	247E4015	56289	0811-0942	1
R135	fxd, comp 750 5% 1/2W	1	EB-7515	01121	0686-7515	1
R136	fxd, comp 30k 5% 1/2W		EB-3035	01121	0686-3035	
R137	fxd, met. oxide 620 5% 2W	1	Type C42S	16299	0764-0063	1
R138	fxd, ww 7.5 5% 2W	1	Type BWH	07716	0811-2553	1
R139	fxd, comp 16 5% 1/2W	1	EB-1605	01121	0698-3561	1
R141	var. ww 500 5% Single-Turn	1	Type CT-100-4	07716	2100-0898	1
R142	fxd, met. film 42.2 1% 1/8W	1	Type CEA T-0	07716	0757-0316	1
R143	Thermistor, disc, 64 10%	1	LB16J1	15801	0837-0023	1

† NOTE: All resistors are in ohms unless otherwise indicated.

§ NOTE: These components are applicable to Options 001 and 002. Components may change for Options 003, 031, and 032. See applicable Option at rear of Table.



REF. DESIG.	DESCRIPTION†	TQ	MFR. PART NO.	MFR. CODE	HP PART NO.	RS
A1R144	var. ww 500 10% Single-Turn	1	Type 110-F4	11236	2100-0328	1
R145	fxd, met. oxide 27k 5% 2W		Type C42S	16299	0764-0007	1
T6	Transformer, Power	1		28480	5080-7158	1
U1,2	Dual Differential Amplifier	2	CA3026	02735	1820-0240	2
U3-5	Operational Amplifier	3	LM301A	07014	1820-0223	3
VR1	Diode, zener 4.22V 5% 400mW	1		28480	1902-3070	1
VR2	Diode, zener 6.8V 400mW	1		28480	1902-0048	1
VR3	Diode, zener 6.2V 5% 400mW	3	1N821	04713	1902-0761	3
VR4	Diode, zener 16.2V 5% 400mW	1		28480	1902-0184	1
VR5	Diode, zener 6.2V 5% 250mW	1		28480	1902-1221	1
VR6,7	Diode, zener 6.2V 5% 400mW		1N821	04713	1902-0761	
VR9	Diode, zener 12.4V 5% 400mW	1		28480	1902-3185	1
VR10	Diode, zener 6.19V 5% 400mW	1		28480	1902-0049	1
A2	Firing Circuits Board	1		28480	5060-7916	
C1	fxd, mylar 0.033 $\mu$ F $\pm$ 10% 200Vdc	3	192P33392	56289	0160-0163	1
C2	fxd, elect. 5 $\mu$ F 65V	3		28480	0180-1836	1
C3	fxd, tantalum 1 $\mu$ F 35V	3		28480	0180-1980	1
C4	fxd, mylar 0.22 $\mu$ F $\pm$ 10% 80Vdc	3	192P2249R8	56289	0160-2453	1
C5	fxd, tantalum 3.3 $\mu$ F 50V	3	150D335X9050B2	56289	0180-2141	1
C11	fxd, mylar 0.033 $\mu$ F $\pm$ 10% 200Vdc		192P33392	56289	0160-0163	
C12	fxd, elect. 5 $\mu$ F 65V			28480	0180-1836	
C13	fxd, tantalum 1 $\mu$ F 35V			28480	0180-1980	
C14	fxd, mylar 0.22 $\mu$ F $\pm$ 10% 80Vdc		192P2249R8	56289	0160-2453	
C15	fxd, tantalum 3.3 $\mu$ F 50V		150D335X9050B2	56289	0180-2141	
C21	fxd, mylar 0.033 $\mu$ F $\pm$ 10% 200Vdc		192P33392	56289	0160-0163	
C22	fxd, elect. 5 $\mu$ F 65V			28480	0180-1836	
C23	fxd, tantalum 1 $\mu$ F 35V			28480	0180-1980	
C24	fxd, mylar 0.22 $\mu$ F $\pm$ 10% 80Vdc		192P2249R8	56289	0160-2453	
C25	fxd, tantalum 3.3 $\mu$ F 50V		150D335X9050B2	56289	0180-2141	
CR1,2	Diode, Si. 200mA 75V	6		28480	1901-0050	6
CR3	Diode, Si. 250mW 200V	6		28480	1901-0033	6
CR4	Stabistor 400mW 10V	9		28480	1901-0460	6
CR5	Diode, Si. 250mW 200V			28480	1901-0033	
CR6,7	Stabistor 400mW 10V			28480	1901-0460	
CR11,12	Diode, Si. 200mA 75V			28480	1901-0050	
CR13	Diode, Si. 250mW 200V			28480	1901-0033	
CR14	Stabistor 400mW 10V			28480	1901-0460	
CR15	Diode, Si. 250mW 200V			28480	1901-0033	
CR16,17	Stabistor 400mW 10V			28480	1901-0460	
CR21,22	Diode, Si. 200mA 75V			28480	1901-0050	
CR23	Diode, Si. 250mW 200V			28480	1901-0033	
CR24	Stabistor 400mW 10V			28480	1901-0460	
CR25	Diode, Si. 250mW 200V			28480	1901-0033	
CR26,27	Stabistor 400mW 10V			28480	1901-0460	
J1	Connector, P.C. Board 44-pin	1	251-22-30-390	71785	1251-0495	1
Q1-3	SS PNP Si.	3		28480	1853-0041	3
R1	fxd, comp 510 5% 1/2W	3	EB-5115	01121	0686-5115	1

†NOTE: All resistors are in ohms unless otherwise indicated.

REF. DESIG.	DESCRIPTION †	TQ	MFR. PART NO.	MFR. CODE	HP PART NO.	RS
A2R2	fxd, comp 2.4k 5% ½W	3	EB-2425	01121	0686-2425	1
R3	fxd, comp 240 5% ½W	3	EB-2415	01121	0686-2415	1
R4	fxd, comp 1.8k 5% ½W	3	EB-1825	01121	0686-1825	1
R5	fxd, comp 5.1k 5% ½W	3	EB-5125	01121	0686-5125	1
R6	fxd, comp 3k 5% ½W	3	EB-3025	01121	0686-3025	1
R7	fxd, met. film 9.09k 1% 1/8W	3	Type CEA T-0	07716	0757-0288	1
R11	fxd, comp 510 5% ½W		EB-5115	01121	0686-5115	
R12	fxd, comp 2.4k 5% ½W		EB-2425	01121	0686-2425	
R13	fxd, comp 240 5% ½W		EB-2415	01121	0686-2415	
R14	fxd, comp 1.8k 5% ½W		EB-1825	01121	0686-1825	
R15	fxd, comp 5.1k 5% ½W		EB-5125	01121	0686-5125	
R16	fxd, comp 3k 5% ½W		EB-3025	01121	0686-3025	
R17	fxd, met. film 9.09k 1% 1/8W		Type CEA T-0	07716	0757-0288	
R21	fxd, comp 510 5% ½W		EB-5115	01121	0686-5115	
R22	fxd, comp 2.4k 5% ½W		EB-2425	01121	0686-2425	
R23	fxd, comp 240 5% ½W		EB-2415	01121	0686-2415	
R24	fxd, comp 1.8k 5% ½W		EB-1825	01121	0686-1825	
R25	fxd, comp 5.1k 5% ½W		EB-5125	01121	0686-5125	
R26	fxd, comp 3k 5% ½W		EB-3025	01121	0686-3025	
R27	fxd, met. film 9.09k 1% 1/8W		Type CEA T-0	07716	0757-0288	
R28	fxd, comp 39k 5% ½W	1	EB-3935	01121	0686-3935	1
R29	fxd, comp 100 5% ½W	1	EB-1015	01121	0686-1015	1
R30	fxd, comp 1k 5% ½W	1	EB-1025	01121	0686-1025	1
T7-9	Transformer, Power	3		28480	5080-7157	1
TB1,2	Terminal Block	2		28480	0360-1674	1
A3	Control Board	1		28480	5060-7918	
C1-9	fxd, ceramic 0.02µF ±20% 2000Vdc	9		28480	0160-2569	2
C10	fxd, ceramic 0.05µF ±20% 400Vdc	1		28480	0150-0052	1
J1	Connector, P.C. Board 44-pin	1	251-22-30-390	71785	1251-0495	1
K2	Contact	1		28480	0490-0967	1
L1-3 §	Inductor, Line	3		28480	5080-7153	1
R1-3 §	fxd, met. oxide 56 5% 2W	2	Type C42S	16299	0764-0013	1
R4	fxd, comp 30k 5% ½W	1	EB-3035	01121	0686-3035	1
R5	fxd, comp 3.3 5% ½W	1	EB-33G5	01121	0686-0335	1
RV1	Varistor 300V	1		28480	0837-0073	1
T1-3 §	Transformer, Bias	1		28480	5080-7155	1
T10,11	Transformer, Power	2		28480	5080-7131	1
DS1	Front Panel Assembly – Electrical Indicator Light ~LINE ON	1		28480	1450-0419	1
DS2	Indicator Light, Overcurrent Protect	1		28480	1450-0708	1
DS3	Indicator Light, Temperature	1		28480	1450-0350	1
M1	Voltmeter, 40V	1		28480	1120-1352	1
M2	Ammeter, 350A	1		28480	1120-1359	1
R1	var. ww 10k 5% Coarse Voltage Adj.	1		28480	2100-1854	1
R2,3	var. ww 300 5% Fine Voltage and Fine Current Adjust	2		28480	2100-1848	1

†NOTE: All resistors are in ohms unless otherwise indicated.

§NOTE: These components are applicable to Options 001 and 002. Components may change for Options 003, 031, and 032. See applicable Option at rear of Table.

REF. DESIG.	DESCRIPTION†	TQ	MFR. PART NO.	MFR. CODE	HP PART NO.	RS
R4 S1	Front Panel Assembly (Continued) var. ww 1k 5% Coarse Current Adjust Switch, Toggle, DPST	1 1	2GK50-73XSV1	28480 73559	2100-1847 3101-0946	1 1
F4-6 F7§,8§	Rear Panel Assembly – Electrical Fuse, 0.3A 600V Fuse, 1.6A 500V	3 2		28480 28480	2110-0398 2110-0401	15 10
C1-16	Output Capacitor Tray – Electrical fxd, elect. 40,000µF 50Vdc	16		28480	0180-1931	4
B1 C17 CR1-3 § CR4-6 § CR7-12 F1-3 § L1 R6 R9-16 T4 § T5 § TC1 §	Main Frame – Electrical Fan fxd, mylar 3µF 200V Rect. Si. 500V 100A SCR 500V 10W Diode, Si. 500V 55A Fuse, 70A 600V Choke fxd, cupron 0.009 TC ±20ppm, Current Sampling fxd, ww 0.33 5% 40W Transformer, Power Transformer, Power Switch, Thermal	1 1 3 3 6 3 1 1 8 1 1 1 1	118P30592S4	28480 56289 28480 28480 28480 28480 28480 28480 28480 28480 28480 28480 28480	3160-0240 0160-2468 1901-1048 1884-0092 1901-0337 2110-0392 06469-80098 5080-7159 0811-1953 06469-80095 5080-7154 3103-0012	1 1 3 3 6 15 1 1 2 1 1 1 1
	<b>MECHANICAL</b>					
	A1 Amplifier Board					
	Bumper, Rubber, 6-32 Thread	1		28480	0403-0088	1
	Socket Relay, 14 Terminal, K1	1	27E007	77342	0490-0402	1
	Heat Sink, A1Q5	1		28480	5000-6025	1
	Card Extractor	2		28480	5020-2045	1
	Rollpin, Extractor	2	52-012-062-0250	72962	1480-0059	1
	A2 Firing Board					
	Socket, Transistor	3	05-3305	91662	1200-0708	1
	A3 Control Board					
	Spacer #10 x 375	6	9319-A-194-0	06540	0380-0471	2
	Standoff 10-32 x 1.000	6	9758-A-1032-0	06540	0380-0728	2
	Front Panel Assembly					
	Knob, Black (R1-R4)	4		28480	0370-0026	1
	Spring, Meter (M1,M2)	8		28480	1460-0256	2
	Bezel, Meter (M1,M2)	2		28480	4040-0297	1
	Hinge, Front Panel, Left	1		28480	5000-6280	1
	Hinge, Front Panel, Right	1		28480	5000-6281	1
	Rear Panel Assembly					
	Cable Clamp	1		28480	0100-0407	1
	Fuse Holder, F4-F8	5		28480	2110-0397	1

†NOTE: All resistors are in ohms unless otherwise indicated.

§NOTE: These components are applicable to Options 001 and 002. Components may change for Options 003, 031, and 032. See applicable Option at rear of Table.

REF. DESIG.	DESCRIPTION	TO	MFR. PART NO.	MFR. CODE	HP PART NO.	RS
	Rear Panel Assembly (Continued)					
	Panel, Rear	1		28480	5000-6282	
	AC Terminal Board, TB1	1		28480	0360-1663	
	Bracket, TB1	1		28480	5000-6283	
	Mounting Plate, TB1	1		28480	5000-6284	
	Output Capacitor Tray					
	Tray, Capacitor (C1-C16)	1		28480	5000-6285	
	Cover, Capacitor Tray	1		28480	5000-6286	
	Busbar, +Output	1		28480	5020-8042	
	Busbar, Choke	1		28480	5020-8041	
	Busbar, -Output	1		28480	5020-8043	
	Pan, Bottom, Right	1		28480	5000-6291	
	Bracket, Capacitor Tray	1		28480	5000-6299	
	Clamp, Capacitor (C1-C16)	1		28480	0160-2590	1
	Spacer, Busbar	12		28480	5020-8011	
	Busbar, Cap	8		28480	5020-8009	
	Busbar, Resistor	1		28480	5020-8010	
	Main Frame Assembly					
	Eye Bolt	2		28480	0570-1101	
	Screw, Socket Heat $\frac{1}{2}$ - 10	8		28480	3030-0370	
	Pan, Bottom, Left	1		28480	5000-6290	
	Post, Corner, Frame	4		28480	5020-8021	
	Bar, Frame	4		28480	5020-8022	
	Tray Assembly, Heat Sink	1		28480	06469-60007	
	Heat Sink, Rectifier (CR7-CR9)	1		28480	5020-8012	
	Heat Sink, Rectifier (CR10)	1		28480	5020-8013	
	Heat Sink, Rectifier (CR11)	1		28480	5020-8014	
	Heat Sink, Rectifier (CR12)	1		28480	5020-8015	
	Bracket, Heat Sink	1		28480	5000-6287	
	Insulator, Heat Sink	4		28480	5020-8036	
	Insulator	20		28480	0340-0172	4
	Shoulder Washer	12		28480	2190-0491	3
	Bracket, Heat Sink	1		28480	5000-6288	
	Busbar, Rectifier	1		28480	5020-8016	
	Spacer, Rectifier	1		28480	06469-20016	
	Support, Heat Sink	1		28480	5020-8045	
	Bushing	6		28480	0340-0168	
	Tray Assembly, P.C. Board	1		28480	5060-7923	
	Standoff, P.C. Boards 32 x $\frac{1}{2}$	7	2322	83330	0380-0093	
	Standoff, P.C. Boards 32 x 1	3	9758-A-1032-0	06540	0380-0728	
	Rubber Grommet 7/8 dia.	3	2187	83330	0400-0063	
	Rubber Grommet $\frac{1}{2}$ dia.	2	2175	83330	0400-0077	
	Guide, P.C. Boards, A1-A3	10		28480	0403-0150	
	Tray	1		28480	5000-6289	
	Heat Sink, SCR, CR1-CR6	3		28480	5020-8017	
	Insulator, Heat Sink	1		28480	5020-8018	
	Insulator, Heat Sink	1		28480	5020-8019	
	Insulator, Heat Sink	1		28480	5020-8020	

REF. DESIG.	DESCRIPTION†	TO	MFR. PART NO.	MFR. CODE	HP PART NO.	RS
	<u>MISCELLANEOUS MECHANICAL</u>					
	Spacer, 8-32 x ½	4	2327	83330	0380-0136	
	Cable Clamp	4	T4-6	79307	1400-0332	1
	Air Filter, Front Panel	1		28480	3150-0217	
	Fuse Block §	1		28480	2110-0393	
	Cover, Top	1		28480	5000-6292	
	Cover, Side	2		28480	5000-6293	
	Bottom, Front Panel	1		28480	5000-6294	
	Bottom, Rear Panel	1		28480	5000-6295	
	Bracket, Filter	2		28480	5000-6296	
	Bracket, Fan, B1	1		28480	5000-6297	
	Bracket, Fan, B1	1		28480	5000-6298	
	Cover, Output Busbars	1		28480	5000-6300	
	Hinge, Mounting Bracket	1		28480	5000-9301	
	Hinge, Mounting Bracket	1		28480	5000-9302	
	Trim Strip	4		28480	5000-9319	
	Cover, Barrier Strip, A2TB1,A2TB2	1		28480	5000-9320	
	Bracket, Fan, B1	1		28480	5000-9321	
	Cover, P.C. Board Protection	1		28480	5000-9322	
	<u>MISCELLANEOUS</u>					
	Carton, Packing	1		28480	9211-1188	
	Base, Wood, Skid	1		28480	9220-1407	
	Floater, Top	1		28480	9220-1408	
	§ OPTION 001 – 208Vac Input See Pages 6-5 through 6-12					
	§ OPTION 002 – 230Vac Input See Pages 6-5 through 6-12					
	§ OPTION 003 – 460Vac Input					
A1	Amplifier Board	1		28480	06469-60024	
R46,50	fxd, comp 18k 5% ½W	2	EB-1835	01121	0686-1835	1
R90,91,110,111	fxd, met. oxide 43 5% 2W	4	Type C42S	16299	0698-3614	1
A3	Control Board	1		28480	5060-7919	
L1-L3	Inductor	3		28480	5080-7156	1
R1-R3	fxd, met. oxide 100 5% 2W	3	Type C42S	16299	0698-3620	1
	Main Frame – Electrical					
F1-F3	Fuse, 60A 600V	3		28480	2110-0391	15
T4	Transformer, Power	1		28480	06469-80097	1
TC1	Switch, Thermal	1		28480	3103-0014	1
	Rear Panel – Electrical					
F7,8	Fuse, 0.6A 500V	2		28480	2110-0402	10
	Frame – Mechanical					
	Fuse Block	1		28480	2110-0396	1

†NOTE: All resistors are in ohms unless otherwise indicated.

§NOTE: These components are applicable to Options 001 and 002. Components may change for Options 003, 031, and 032. See applicable Option at rear of Table.

REF. DESIG.	DESCRIPTION †	TO	MFR. PART NO.	MFR. CODE	HP PART NO.	RS
	OPTION 006 – Overvoltage Crowbar					
A2	Firing Circuit Board	1		28480	06469-60023	
C27	fxd, elect. 490 $\mu$ F 85V	1		28480	0180-1888	1
C30	fxd, ceramic 0.47 $\mu$ F 25V	1		28480	0160-0174	1
C33	fxd, ceramic 510pF 500V	1		28480	0140-0047	1
CR30-33	Diode, Si. 0.75A 200prv	4		28480	1901-0327	4
CR34,35	Diode, Si. 180V 200prv	2		28480	1901-0033	2
CR36	SCR 600V 2A	1		28480	1884-0044	1
Q7	SS PNP Si.	1		28480	1853-0041	1
Q8	SS PNP Si.	1		28480	1853-0099	1
Q9	Power NPN Si.	1		28480	1854-0224	1
Q10	SS NPN Si.	1		28480	1854-0244	1
R32	fxd, comp 75 5% 1/2W	1	EB-7505	01121	0686-7505	1
R33	fxd, comp 130 5% 1/2W	1	EB-1315	01121	0686-1315	1
R34,35	fxd, comp 1.5k 5% 1/2W	3	EB-1525	01121	0686-1525	1
R36	fxd, comp 2k 5% 1/2W	4	EB-2025	01121	0686-2025	1
R37	fxd, comp 470 5% 1/2W	1	EB-4715	01121	0686-4715	1
R38	fxd, comp 2k 5% 1/2W		EB-2025	01121	0686-2025	
R41,42	fxd, met. oxide 43 5% 2W	2	Type C42S	16299	0698-3614	1
R43	fxd, comp 1k 5% 1/2W	1	EB-1025	01121	0686-1025	1
R44	fxd, ww 1.3k 5% 3W	1		28480	0811-1803	1
R45,46	fxd, comp 2k 5% 1/2W		EB-2025	01121	0686-2025	
R50	fxd, comp 1.5k 5% 1/2W		EB-1525	01121	0686-1525	
R51,52	fxd, comp 300 5% 1/2W	3	EB-3015	01121	0686-3015	1
R53	fxd, comp 750 5% 1/2W	1	EB-7515	01121	0686-7515	1
R54	fxd, comp 300 5% 1/2W		EB-3015	01121	0686-3015	
VR11	Diode, zener 6.19V 5% 400mW	1		28480	1902-0049	1
	Main Frame – Electrical					
CR37,38	SCR	2		28480	1884-0040	2
DS4	Indicator Light	1		28480	1450-0708	1
R5	var. ww 1k	1		28480	2100-1847	1
R47,48	Cupron	2		28480	06469-80004	1
T12	Transformer, Crowbar	1		28480	5080-7177	1
	OPTION 023 – Rack Mounting Kit					
	Nut, Retainer	12		28480	0590-0789	
	Ear, Rack Mounting	2		28480	5020-8037	
	§ OPTION 031 – 380Vac Input					
A1	Amplifier Board	1		28480	06469-60025	
R90,91,110,111	fxd, ww 39 5% 2W	4	Type BWH	07716	0811-2244	1
A3	Control Board	1		28480	5060-7936	
L1-3	Inductor	3		28480	5080-7156	1
R1-3	fxd, met. oxide 100 5% 2W	3	Type C42S	16299	0698-3620	1
T1-3	Transformer, Bias	3		28480	5080-7179	1
	Main Frame – Electrical					
CR1-3	Diode, Si. 1000V 100A	3		28480	1901-1047	3
CR4-6	SCR 1000V 55A	3		28480	1884-0083	3

†NOTE: All resistors are in ohms unless otherwise indicated.

REF. DESIG.	DESCRIPTION	TQ	MFR. PART NO.	MFR. CODE	HP PART NO.	RS
	OPTION 031 (Continued)					
F1-3	Fuse, 60A 600V	3		28480	2110-0391	15
T4	Transformer, Power	1		28480	06469-80096	1
T5	Transformer, Fan	1		28480	5080-7178	1
	Rear Panel - Electrical					
F7,8	Fuse, 0.6A 500V	2		28480	2110-0402	10
	Frame - Mechanical					
	Fuse Block	1		28480	2110-0396	1
	§ OPTION 032 - 400Vac Input Same as Option 031 Above					

## SECTION VII CIRCUIT DIAGRAMS AND COMPONENT LOCATION DIAGRAMS

This section contains the circuit diagrams necessary for the operation and maintenance of this power supply. Included are:

- a. Component location photographs (Figures 7-1 through 7-5), showing the physical location and reference designators of parts mounted on the printed circuit boards and chassis.
- b. Firing circuit waveforms (Figure 7-6), showing the waveforms found at various points in the firing circuit.
- c. Schematic diagram (Figure 7-7), illustrating the circuitry for the entire power supply. Voltages are given adjacent to test points, which are identified by encircled numbers on the schematic.



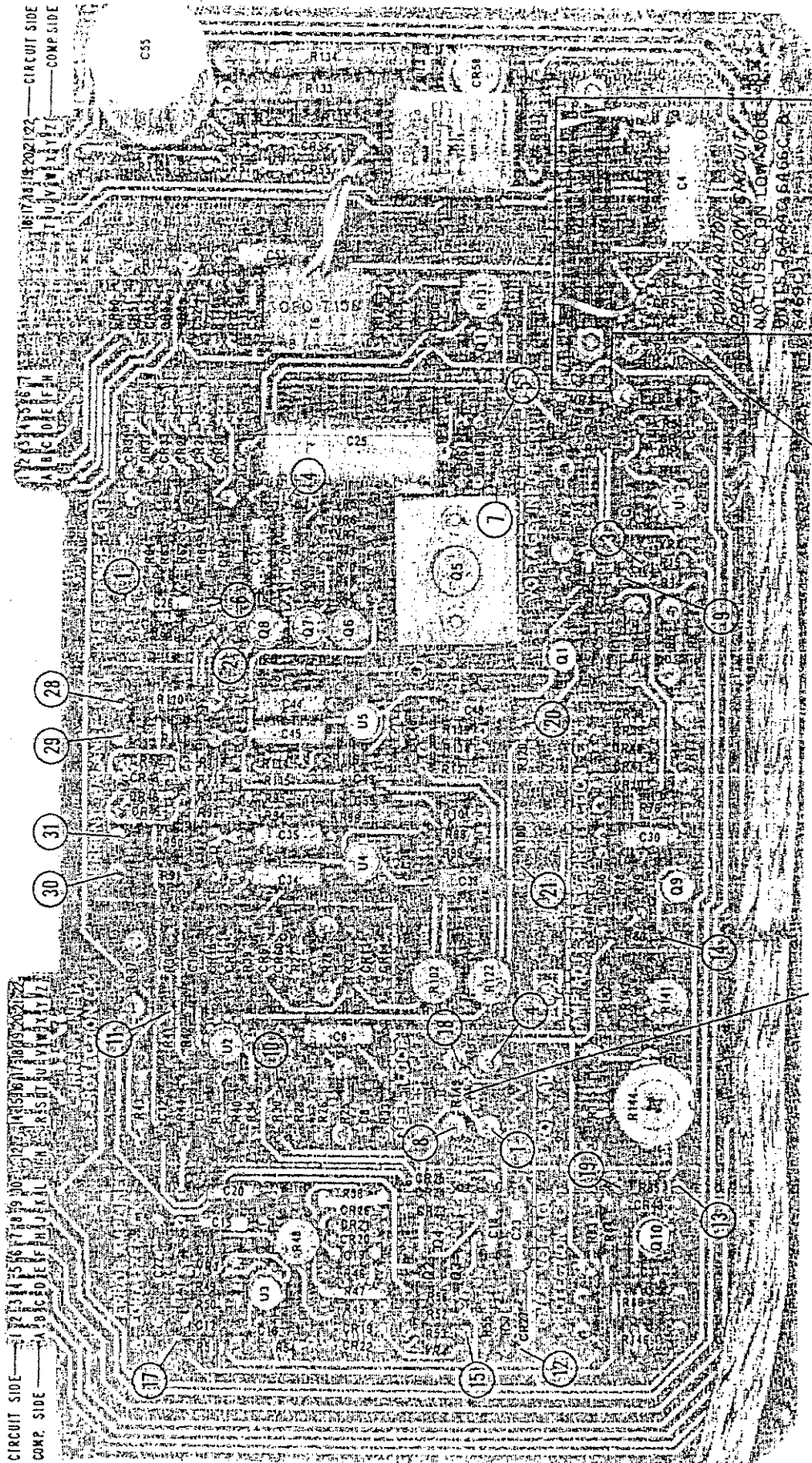

JUMPER (R7) MUST BE REMOVED FOR AUTO-SERIES, BATTERY DISCHARGING OR REMOTE VOLTAGE PROGRAMMING

JUMPER (R149) REMOVED FOR OPEN LOOP TEST

Figure 7-1. A1 Amplifier Board, Component Location

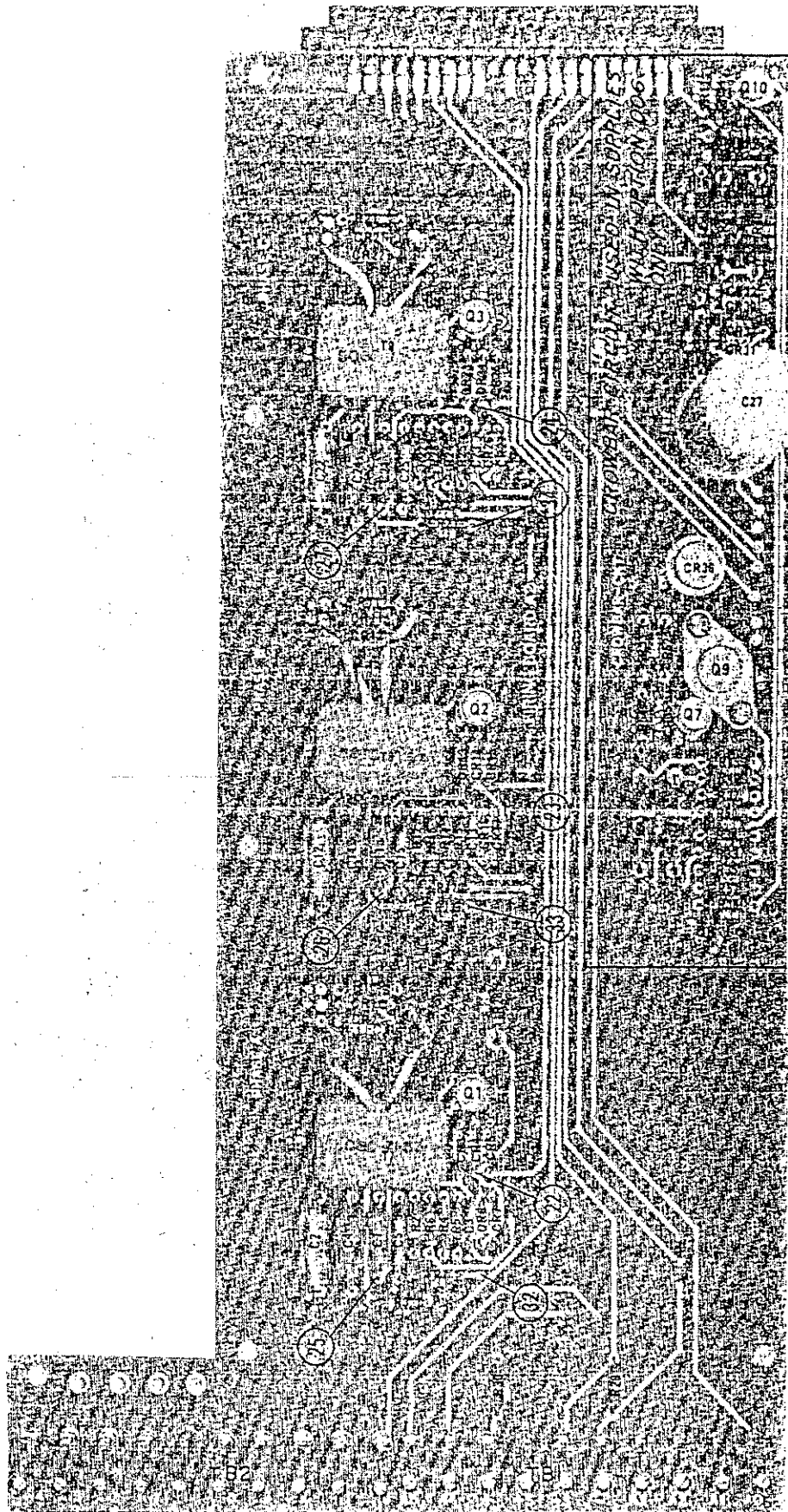

Figure 7-2. A2 Firing Board, Component Location

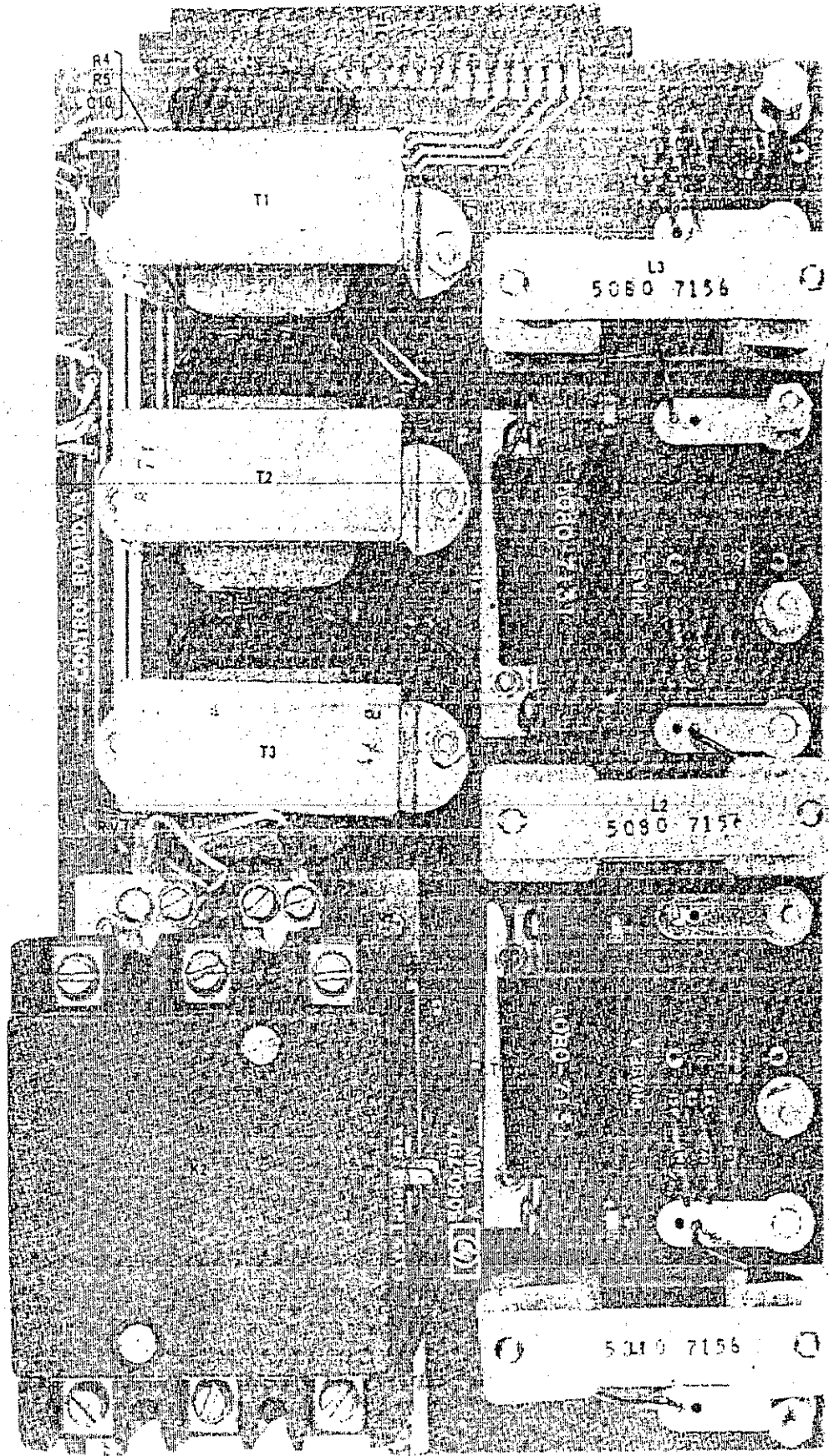
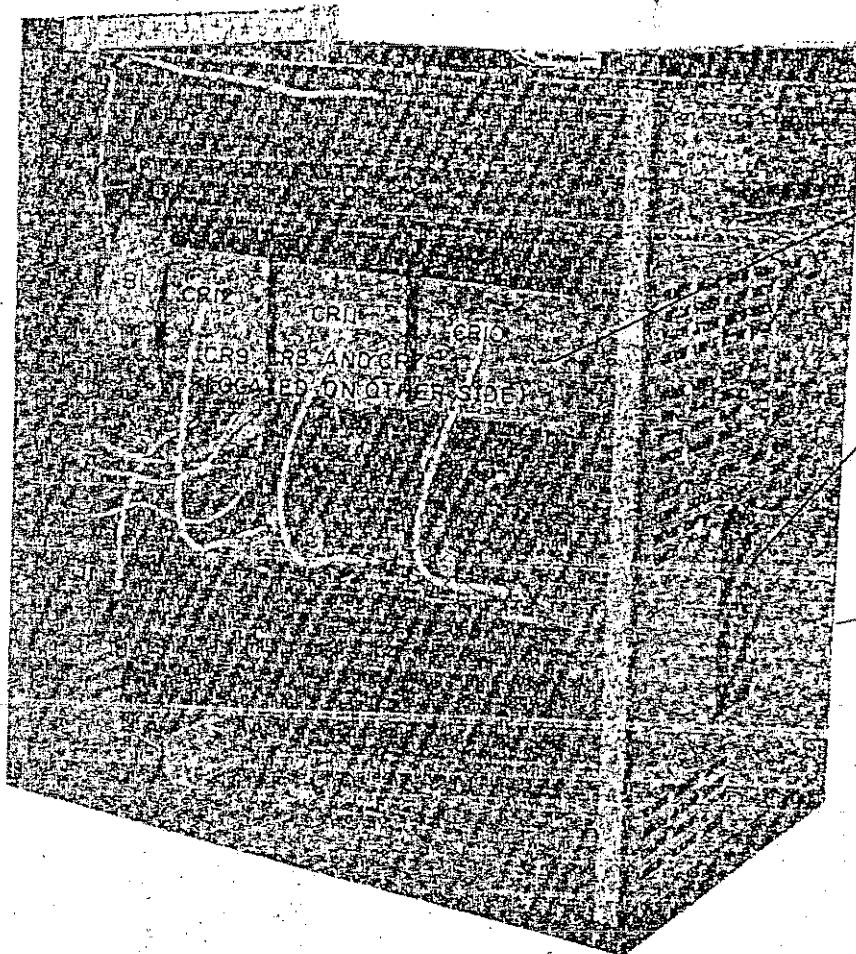

Figure 7-3. A3 Control Board, Component Location



NOTE: FINNED HEAT SINK USED ON LOWER VOLTAGE MODELS, BUT DIODES ARE IDENTICALLY POSITIONED.

NOTE: BUS BARS ARE MOUNTED DIFFERENTLY ON LOWER VOLTAGE MODELS.

OUTPUT CAPACITORS (LOCATED ON OTHER SIDE)

NOTE: THIS PHOTO APPLIES DIRECTLY TO THE HIGHER VOLTAGE MODELS OF THE SCR-10 SERIES. FOR LOWER VOLTAGE MODELS (6464C, 6466C AND 6469C) COMPONENT LOCATIONS ARE IDENTICAL, BUT THE PHYSICAL APPEARANCE OF THE UNIT VARIES SLIGHTLY.

Figure 7-4. Chassis, Side View, Component Location

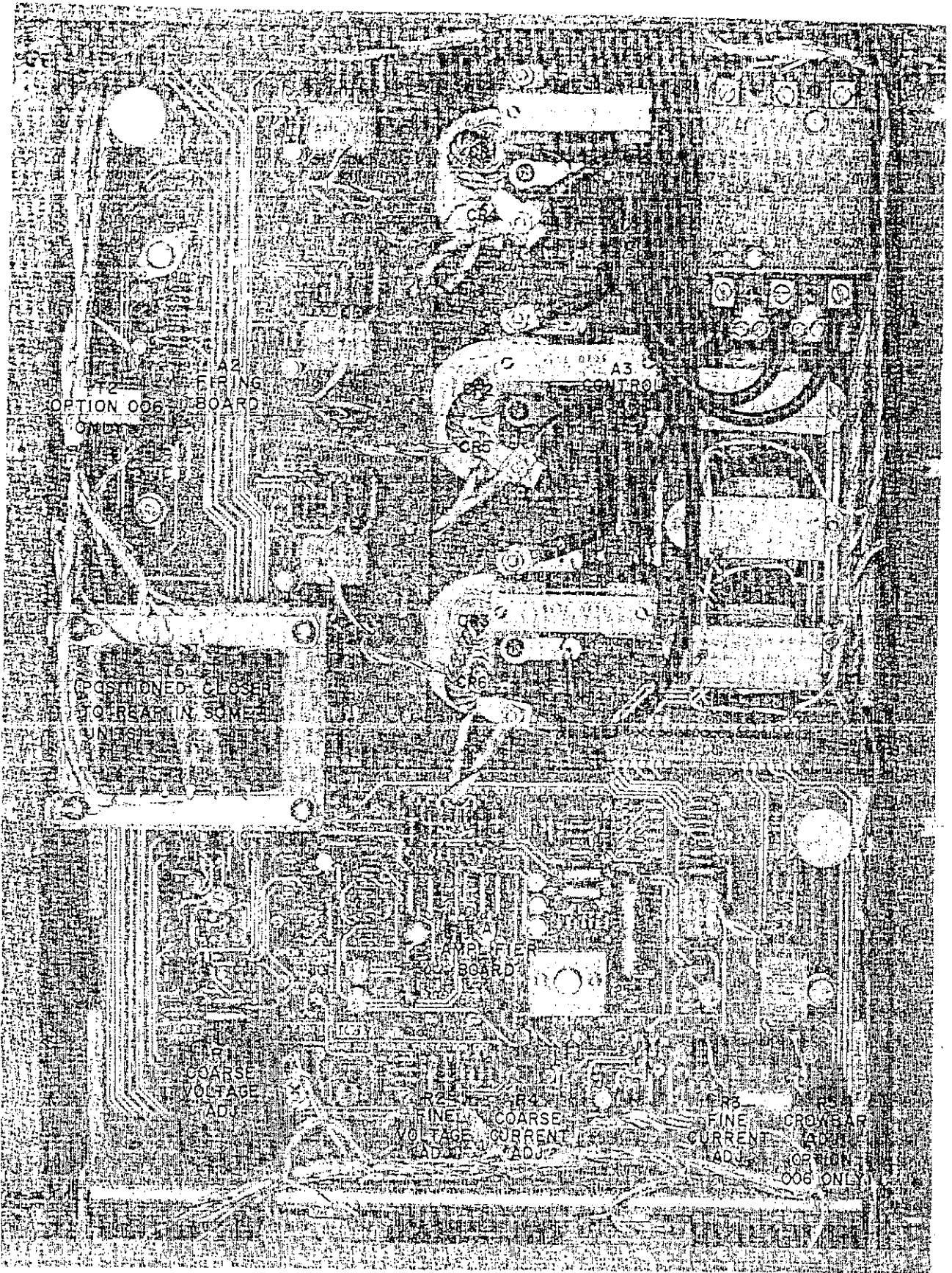
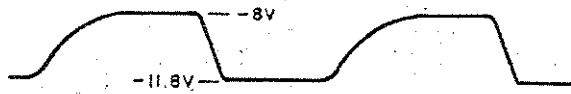

Figure 7-5. Top View, P.C. Board and Component Location

MEASUREMENT CONDITIONS

1. ALL MEASUREMENTS REFERENCED TO CIRCUIT COMMON (TERMINAL A7) UNLESS OTHERWISE INDICATED.
2. AMPLITUDES ARE TYPICAL  $\pm 10\%$ .
3. OSCILLOSCOPE D.C. COUPLED, HORIZONTAL PERIOD IS 2 MILLISECONDS/CM.
4. WAVEFORMS TAKEN WITH LOOP OPEN AND NO LOAD CONNECTED EXCEPT FOR BOTTOM TWO WAVEFORMS.



TP22, 23, OR 24  
(Q1, Q2, OR Q3 OFF)

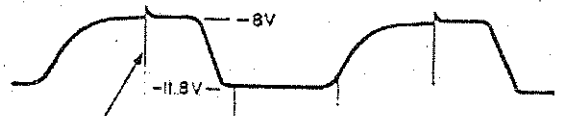

TP22, 23, OR 24  
(Q1, Q2, OR Q3 ON)

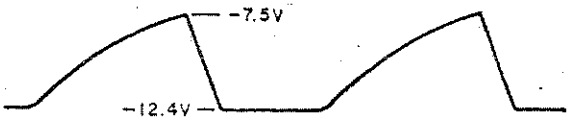

TP25, 26, OR 27  
(Q1, Q2, OR Q3 OFF)

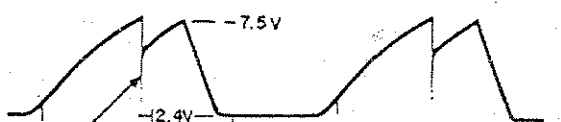

TP25, 26, OR 27  
(Q1, Q2, OR Q3 ON)

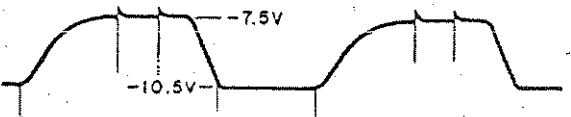

TP22, 23, OR 24  
CLOSED LOOP, FULL LOAD

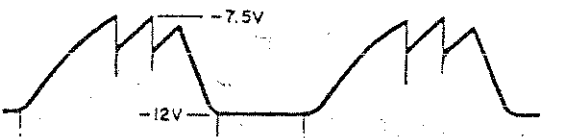

TP26, 26 OR 27  
CLOSED LOOP, FULL LOAD

Figure 7-6. Firing Circuit Waveforms

## APPENDIX A

### Option 006, Overvoltage Protection Crowbar

#### DESCRIPTION

This option is installed and tested at the factory. It is applicable to Models 6466C, 6469C, 6472C, 6475C, 6477C, 6479C, and 6483C. Option 006 consists of components mounted both on the power supply chassis and on the firing board, A2. A front panel control (CROWBAR ADJUST) is provided to set the trip level and, in addition, a lamp (CROWBAR) is included to indicate that the crowbar circuit has fired.

#### NOTE

*If the crowbar circuit fires, both the CROWBAR lamp and the OVERCURRENT PROTECT lamps on the front panel will light. (Refer to Overall Troubleshooting Tree, Figure 5-8.)*

The crowbar circuit, Figure A-1, monitors the output voltage of the supply (across the +S terminal and the -OUT bus) and fires an SCR (or two SCR's depending upon the current rating of the supply) that effectively shorts the output if the preset trip voltage is exceeded. The trip voltage is determined by the setting of the CROWBAR ADJUST control (R5) on the front panel. The trip voltage range is as follows:

<u>Model</u>	<u>Trip Voltage Range (Approximate)</u>
6466C	8-20V
6469C	18-40V

6472C	32-70V
6475C	55-120V
6477C	110-240V
6479C	150-330V
6483C	300-660V

To prevent transients from falsely tripping the crowbar, the trip voltage must be set higher than the power supply output voltage by a margin of 10% of the output voltage. The margin represents the minimum crowbar trip setting for a given output voltage; the trip voltage can always be set higher than this margin.

#### OPERATION

1. Turn the CROWBAR ADJUST fully clockwise to set the trip voltage to maximum.
2. Set the power supply VOLTAGE control for the desired crowbar trip voltage. To prevent false crowbar tripping, the trip voltage should exceed the desired output voltage by 10%.
3. Slowly turn the CROWBAR ADJUST ccw until the crowbar trips: the CROWBAR and OVERCURRENT PROTECT lights come on and the output falls to near 0 volts.
4. The crowbar remains activated and input power is removed from the supply until it is reset. To reset, turn the supply off, wait three seconds, and then turn on the supply.

#### REPLACEABLE PARTS

All of the crowbar circuit components are shown on Figure A-1 and listed in Table 6-4 under Option 006.









MANUAL CHANGES  
Model 6469C DC Power Supply  
Manual HP P/N 06469-90002

12/19/89

Make all corrections in the manual according to errata below, then check the following table for your power supply serial number and enter any listed changes(s) in the manual.

SERIAL		MAKE CHANGES
Prefix	Number	
All	---	Errata
1125A	00106-00123	1,10
1125A	00124-00132	1,2,10
1125A	00133-00144	1,2,3,10
1125A	00145-00175	1-4,10
1125A	00176-00179	1-5,10
1125A	00180-00300	1-6,10
1125A	00301-00376	1-7,10
1125A	00377-00689	1-8,10
2329A	00690-00886	1-9,10
2614A	00887-up	1-9,11

**ERRATA:**

In the replaceable parts table and on the schematic as applicable, make the following changes:

Under Main Frame - Electrical,

R6: Change R6 to 0.0009 to +/-20ppm.

R9-R16: Change R9-R16 to 1.3 ohm, 40 W HP P/N 0811-1956. Under Amplifier Board A1, R131: Change R131 to HP P/N 2100-1774. On page 6-12, under Option 003, add the following parts: CR1-3; Diode, Si. 1000V 100A; HP P/N 1901-1047.

**CHANGE 1:**

In the replaceable parts table and on the schematic applicable, make the following changes: Under Amplifier Board A1: Change A1R127 to 27.4K, 1/8 W, HP P/N 0757-0452. Under Control Board A3: Change A3T10 and A3T11 to HP P/N 5080-7187. Under Main Frame - Electrical: C18: Add C18, .02 microfarad, 2k V, HP P/N 0160-2569. On the schematic C18 is connected between the -OUT buss and the chassis. R17: Change R17 to 1.8 ohm, 2W, HP P/N 0811-1669. Under Firing Circuits Board A2: A2C33: Add A2C33, 510pf, HP P/N 0140-0047. On the Crowbar Schematic. A2C33 is connected between the -OUT buss and the base of Q10.

On page 6-12, add the following changes for Option 005, 50Hz operation. OPTION 005 -50Hz Input

A1R91 and A1R111: A1R91 and A1R111 are deleted and jumpers installed. A1R127: Change A1R127 to 40.2k, 1/4 W, HP P/N 0698-3210.

**CHANGE 2:**

In the replaceable parts table and on the schematic as applicable, make the following changes: Under Amplifier Board A1, A1C2: Delete A1C2 and add a jumper. A1CR12: Delete A1CR12. A1R12: Change A1R12 to 8.2 k ohm +/-5% ,1/2 W, HP P/N 0686-8225.

**CHANGE 3:**

In the replaceable parts table under Amplifier Board A1 and on the schematic, change A1R52 to 200 ohm, +/-5%, 1/2 W, HP P/N 0686-2015.

**CHANGE 4:**

In the replaceable parts table and on the schematic, add C19, 8 microfarad, 370W Vac, HP P/N 0160-4022. C19 is mounted across fan B1.

**CHANGE 5:**

In the parts list, under Mechanical, change the HP P/N of heat sink (SCR, CR1-CR6) to 5020-8450, qty 3.

In parts list, under Options 003 and 031, change HP P/N of CR4-CR6 to 1884-0226.

**CHANGE 6:**

In parts list, under Main Frame - Electrical, change HP P/N of CR4-CR6 to 1884-0225.

**ERRATA:**

In parts list, under Mechanical, change the HP P/N of the cable clamp to 0100-0437.

In parts list under Main Frame - Electrical and on schematic, change C19 HP P/N to 0160-4122. C19 is connected across B1.

On page 3-4, change title of Figure 3-4 to read: "Remote Voltage Programming, Constant Voltage, Unity Gain."

In the parts list under Main Frame - Electrical, and on schematic, change R6 to .0009 ohms HP P/N 5080-7159.

ERRATA:

Add the following at the end of paragraph 2-17: Fuses F1, F2, and F3 (70A each), in the phase A, B, and C lines respectively, are located inside the unit behind the rear panel. Fuses F4, F5 and F6 (300mA each), connected in the reference supply power input circuit, are located on the rear panel. Fuses F7 and F8 (1.6A each), in the phase B and C input lines to the T5 primary windings, are also located on the rear panel.

In paragraphs 4-18 and 4-24, change 40% to 140%.

In Figure 3-5, connect programming resist between terminals A4 and A6 as shown below. Programming resistor should not be connect to terminal A8.

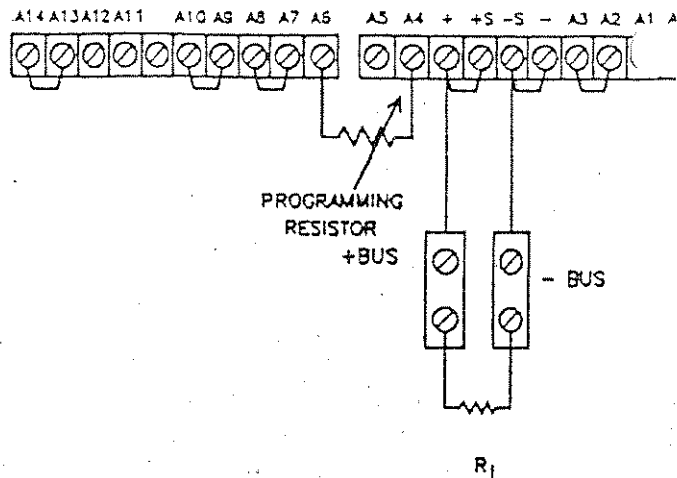

Figure 3-5. Remote Resistance Programming, Constant Current

The standard colors for this instrument are now mint gray (for front panel) and olive gray (for all other external surfaces). Option X95 designates use of the former color scheme of light gray and blue gray. Option A85 designates use of a light gray front panel with olive gray used for all other external surfaces. New part numbers are shown below:

DESCRIPTION	STANDARD	HP PART NO.	
		OPTION A85	OPTION X95
Front Panel Assembly	06464-60004	<-----	<-----
Front Panel Lettered	06464-60013	06464-60005	<-----
Cover, Top	5000-9417	<-----	5000-6292
Cover, Side (2)	5000-9418	<-----	5000-6293
Bottom, Front Panel	5000-9447	5000-6294	<-----
Cover, Output Busbar	5000-9467	5000-6300	<-----
Cover, Barrier Strip	5000-9457	<-----	5000-9320
Bottom, Rear Panel	5000-9466	5000-6295	<-----
Panel, Rear	5000-6282	5000-6283	<-----
Mounting Plate	5000-9465	5000-6284	<-----
Pan, Bottom, Left	5000-9480	<-----	5000-6290
Bracket, Heat Sink	5000-9477	<-----	5000-6287
Bracket, Heat Sink	5000-9477	<-----	5000-6288
Post, Corner Frame (2)	5020-8446	<-----	5020-8021
Bar, Frame (2)	5020-8448	<-----	5020-8022
Tray, Capacitor	5000-9453	<-----	5000-6285
Cover, Capacitor Tray	5000-9454	<-----	5000-6286
Tray	5000-9479	<-----	5000-6289
Ear, Rack Mounting (2), Option 23	5020-7062	5020-8037	<-----
Front Panel (Crowbar	5000-9382	5000-9324	<-----

ERRATA:

In the replaceable parts table, change the HP P/N of pilot lamp DS1 to 1450-0566. The new pilot lamp is more reliable because its leads are crimped instead of being spot welded.

Add the following to the "Ordering Additional Manuals" paragraph in Section I: "Effective Dec. 1975, extra manuals may be obtained by specifying Option 910 when ordering your instrument. The number of extra manuals depends upon the quantity of Option 910s ordered."

Insert the following CAUTION notice after paragraph 3-45 (Auto-Parallel Operation).

CAUTION

Ensure that the resistances of the load leads/connections for each supply are equal.

Make the following corrections to paragraph 5-46: Change the first sentence of step (f) to "Voltage should read 2 to 4 volts with VOLTAGE controls fully ccw." Change the first sentence of step (h) to "Voltage should read 5 to 9 volts with VOLTAGE controls fully cw."

CHANGE 7:

In Option 031 (380Vac) and Option 032 (400V) instruments, fan transformer T5 has been changed to a new type and its fuses, F7 and F8, have been changed to a new type and its fuses, F7 and F8, have been changed in rating. The new part number for T5 is 5080-1874. F7 and F8 are now 1-amp, 500 V, time delay fuses, type FNQ-1, HP P/N 2110-0558 (In instrument serial number 1125A-00301, transformer T5 is marked 5080-7178 Rev. C. This transformer is identical to the new 5080-1874.)

CHANGE 8:

In replaceable parts table, A3 Control Board, replace current transformer T10,11 with HP P/N 5080-1911.

ERRATA:

On page 6-7 of the parts list, change the HP P/N of resistor A1R141 to 2100-1772. The resistor has not been changed; just its part number has.

In paragraph 5-83 on page 5-13, the figures in the Resistor Value column of step (c) are all incorrect. The proper resistor value for programming full rated output current in all of the listed models (6464C through 6483C) is 1000 ohms.

Add to paragraph 2-12 the statement that four eyebolts are provided that can be attached to the top of the unit if a hoist must be used to lift it. On page 6-11, change the quantity of eyebolts to four. Add to paragraph 1-10, the statement that the standard supply (ordered with or without accessory casters) includes four adjustable screw-in feet (HP P/N 19099-60860).

Change variable resistor A1R102 to 20k ohm, 1/2W HP P/N 2100-0558.

On page 6-9, change HP P/N of DS2 to 1450-0591 and change HP P/N of DS3 to 1450-0590 and on page 6-13 change HP P/N of DS4 to 1450-0591.

CHANGE 9:

In the parts list, on pages 6-6 and 6-13, change CR58 and CR36 to HP P/N 1884-0302.

ERRATA:

On page 5-13, paragraph 5-75, step b, and paragraph 5-76, step a and c change -S to +S.

On page 5-13, paragraph 5-76, step c, change the resistor values for the 6472C, 75C, 77C, 79C and 83C to the values shown below.

MODEL VALUE (ohms)

MODEL	VALUE (ohms)
6472C	19.2 K
6475C	33 K
6477C	66 K
6479C	90 K
6483C	180 K

On page 3-1 after the NOTE and on page 5-2 after paragraph 5-9 add, the following WARNING and Table.

WARNING

Violent arcing could occur if terminals are shorted at any time with power on. Turn AC power off and wait one minute before shorting.

Hazardous voltage may remain on terminals after AC power is removed. Check terminal voltages before touching.

MODEL	VOLTAGE (Maximum allowable terminal voltage before terminals are shorted)
6464C	5 V
6466C	6 V
6469C	8 V
6472C	10 V
6475C	17 V
6477C	30 V
6479C	30 V
6483C	42 V

On page 3-1, paragraph 3-2, change step c. to read as follows: To check out constant current circuit, first *turn off supply and allow the output voltage to bleed down*. Then short circuit the output bus bars and rotate Voltage controls fully clockwise. Turn-on supply.

On page 3-2, paragraph 3-8, add the following sentence to the beginning of step b.; *Turn off supply and allow the output voltage to bleed down*.

Add this same sentence to paragraph 3-10, step a, paragraph 3-55, steps b and d, and paragraph 5-32, step e.

In the Replaceable parts list, and on the schematic diagram change variable resistors A1R102 and A1R122 to 20 K, 1/2 W, HP 2100-0058.

**CHANGE 10:**

One of two types of cooling fans is installed in this supply, HP P/N 3160-0240 or 3160-0285. The capacitor (C19) to be used with the fan depends on which fan is installed. With fan 3160-0240, use 8uF 370 Vms capacitor, HP P/N 0160-4122. With fan 3160-0285, use 5uF 370 Vrms capacitor, HP P/N 0160-0585.

**CHANGE 11:**

In the replaceable parts list, page 6-10, under Main Frame - Electrical change Fan, B1 to Fan Assembly, B2, HP P/N 3160-0498 and on page 6-12, under Miscellaneous Mechanical, change Bracket, Fan, B2 to HP P/N 5020-2684.

**ERRATA:**

In the replaceable parts list, page 6-10 under Rear Panel Electrical and on schematic, figure 7-7, change the description for F4, F5 and F6 to; Fuse can be 0.3A or 0.315A 600V.

**ERRATA:**

In the Operating and Service manual, units with Option 040, add the following note.

**NOTE**

When calibrated for Option 040, units may meet full output voltage or current specification when used with the front panel potentiometer. This is due to the resistance tolerance of the potentiometer and programming coefficient accuracy required Option 040.

**ERRATA:**

On page 5-2 in paragraph 5-9 in the parenthesis change "at least 10%" to "10% at the maximum rated output current for power supply".

## POWER SUPPLY MODIFICATION

FEB. 23, 1993

CONVERT MODELS 6464C-6483C to 6464C-6483C-J30

### Purpose:

To permit the output voltage of the supply to be programmed, with gain, by a remote voltage source such as the 59501A Isolated D/A Power Supply Programmer.

### Factory Modification:

Description. A new circuit has been added (see attached schematic) to accomplish this modification. All of the new circuitry is mounted on a separate P.C. board which has been installed inside the unit.

The circuit consists of a voltage-to-current converter and an associated bias supply. A 0-to-10 Vdc programming voltage applied to the new + and - programming terminals at the rear of the supply is converted to an output current at the collector of Q2 which varies according to the magnitude of the input voltage. This current is then summed with the normal constant voltage programming current (at terminal A0 inside the main supply) and the resultant programming current is used to control the output voltage of the supply.

Resistor R4 provides protection against the possibility of open programming terminals; CR3 and R9 protect against the application of a reverse programming voltage. Emitter follower stage Q1 furnishes temperature compensation for the base-emitter junction of Q2. Stage Q2 acts as a variable current source whose output is determined by the amplitude of the programming voltage applied to the base. Resistor R10 provides a means of calibrating the programming current that flows out of Q2. As mentioned previously, this current is injected into the original power supply circuit at terminal A0 where it opposes the normal programming current produced by current source Q5. The resultant programming current flowing through the front panel VOLTAGE controls (or an external programming resistor) determines the output voltage of the power supply. When the current flowing out of Q2 is at a maximum, the supply output is at a minimum, and vice-versa.

Operation. This unit can be programmed by a 59501A or any device which can provide 0 to +10 Vdc. The following relationships exist between the programming input voltage and the supply output voltage:

$$\begin{aligned} 1V \text{ Ein} &= 10\% E_{\text{out}} \\ 10V \text{ Ein} &= 100\% E_{\text{out}} \\ 0V \text{ Ein} &= 0V E_{\text{out}} \end{aligned}$$

Linearity over the programming span from 10% to 100% of rated output voltage is better than 2%. The linearity is not specified over the low end of the band (0 to 10%) because of the inherent minimum operating thresholds associated with all SCR supplies at low outputs.

If the front panel VOLTAGE controls are to be left connected in the circuit (strap between A2 and A3), they must be set to maximum resistance (fully CW). If the controls are rotated CCW, the output voltage of the supply will be decreased for all programming input voltages. If desired, the user may disable the front panel controls (remove the strap between A2 and A3) and substitute a fixed resistor of equal value in their place (terminal A2 to +S). Note that to avoid degrading the stability and temperature coefficient specifications of the power supply, the fixed resistor should have as low a TC as possible (preferably less than 30 ppm/°C), and a rated power dissipation of at least  $10 \times I^2 R$ , where I is the adjusted programming current of the power supply (approximately 4.1A for supplies over 50V, and 5.8A for supplies under 50V).

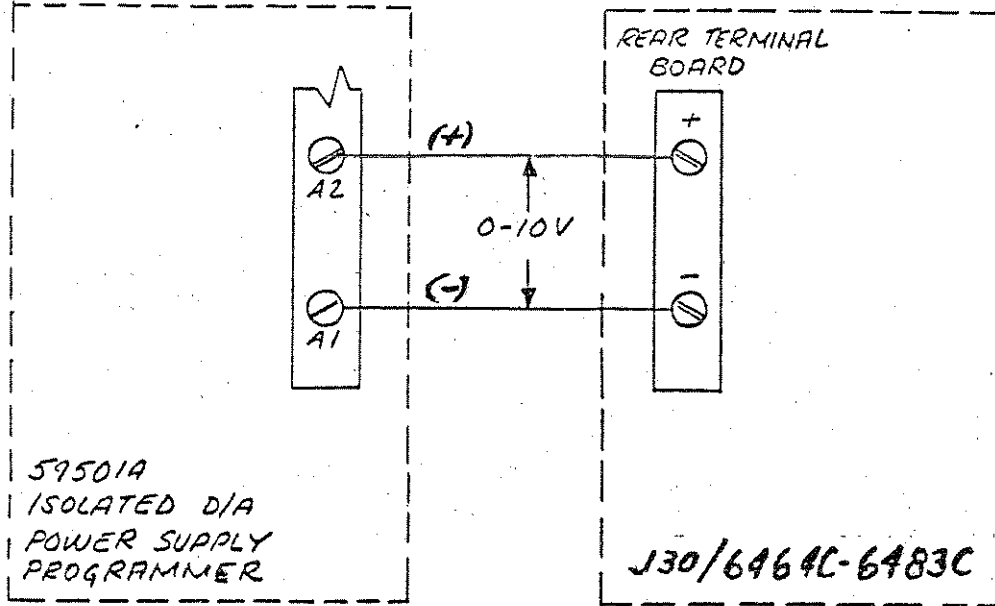

59501A/J30 Connection Diagram

WARNING

If remote programming terminals are open circuited, the power supply will rise up to 25% of the rated output voltage.



**Programming Accuracy Adjustment.** To adjust the programming current, and thus the remote programming accuracy, proceed as follows:

- a. Adjust R1 (on new P.C. board) to obtain +12.0Vdc bias.
- b. Set front panel VOLTAGE controls to maximum or connect external programming resistor as described in previous paragraph.
- c. Remove A1R8 and replace with 1K, 3W resistor (Models 6472C-6483C) or 680 $\Omega$ , 3W resistor (Models 6464C-6469C). This increases the power supply programming current approximately 0.8mA in order to insure that Q2 remains in its linear operating region at all times.
- d. Replace A1R9 with decade resistance box and set for approx. 15k.
- e. Connect another decade resistance box in R10 position (on new P.C. board) and set input programming voltage to 1.0V. Adjust decade box to obtain 10% of rated output voltage.
- f. Set input programming voltage to 10.0V. and adjust A1R9 decade for 100% of rated output.
- g. Repeat steps e and f and readjust (some interaction will occur).
- h. Replace decade boxes with appropriate value, 1%, 1/8W fixed resistors.

#### REPLACEABLE PARTS, REMOTE VOLTAGE PROGRAMMING BOARD

REF. DESIG.	DESCRIPTION	TQ	HP PART NO.
C1	300 $\mu$ F 40Vdc	1	0180-1805
C2	33pF 300V	1	0160-2150
C3, C4	.015 $\mu$ F 1kVDC	2	0160-2477
CR1, CR2	Rectifier 200V 1A	2	1901-0327
CR3	Diode 200V 100mA	1	1901-0033
Q1	NPN Transistor	1	1854-0823
Q2	PNP Transistor	1	1853-0099
R1 (6464C-6469C)	10K Potentiometer	1	2100-3210
R2 (6472C-6483C)	3K 3W ww	1	0812-0010
R2	4.3K 3W ww	1	0811-1811
R4	2K 1/2W	1	0686-2025
R5	10K 1/4W	1	0683-1035
R6	1K 1/4W	1	0683-1025
R7	6.8K 1/8W	1	0683-6825
R8	5.1K 1/8W	1	0757-0941
R9	1K 1/8W	1	0757-0924
R10	Selected 1/8W	1	---
T1	Bias Transformer (115V primary)	1	5080-1816
U1	OP-AMP LM301	1	1820-0223
VR2	6.2V Zener Diode	1	1902-0761



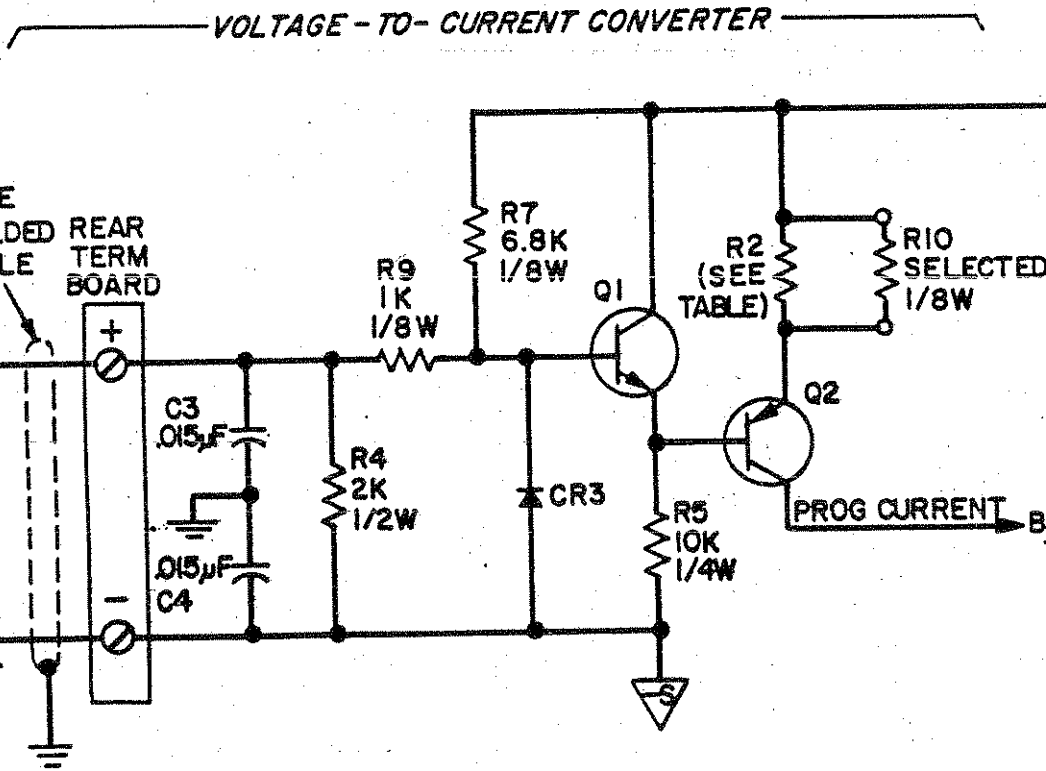
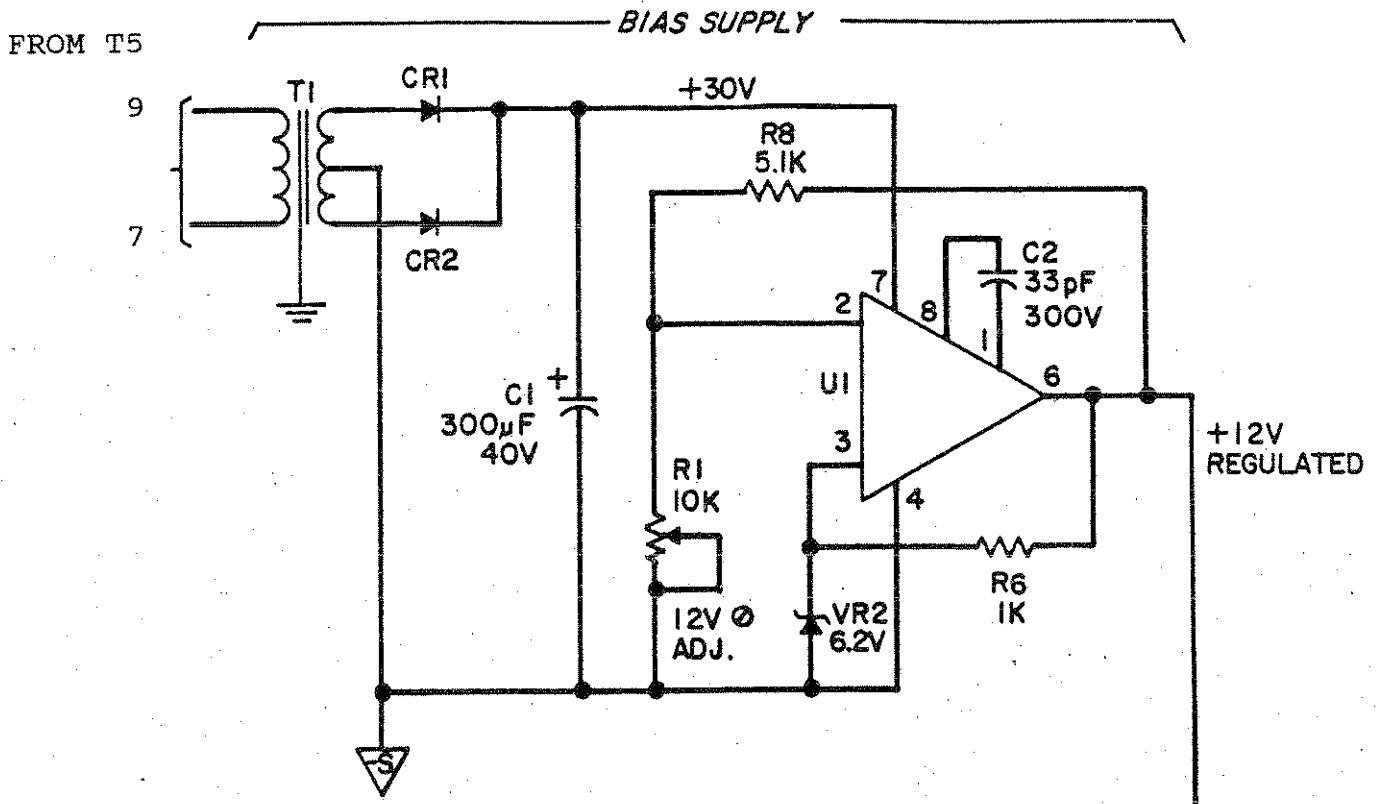

MODEL	R2
6464C-	3K
6469C	3W
6472C-	4.3K
6483C	3W

J30/6464C-6483C REMOTE VOLTAGE PROGRAMMING CIRCUIT

